



INSTRUCTION MANUAL

IP ADVANCED RADIO SYSTEM
IP501H

1 BEFORE USING

2 BASIC OPERATION

3 ADVANCED OPERATION

4 SET MODE

5 OPTIONAL PRODUCTS

6 FOR YOUR REFERENCE

INDEX

TABLE OF CONTENTS

1. BEFORE USING	1-1	5. OPTIONAL PRODUCTS	5-1
■ Attaching the antenna	1-2	■ Optional products.....	5-2
■ Attaching the hand strap.....	1-2	■ Standard charging time and battery life	5-3
■ Attaching the belt clip	1-2	■ Battery pack cautions	5-4
■ Attaching the battery pack	1-2	■ Charging with the optional BC-202IP2	5-6
■ Turning ON the power/Adjusting the audio level	1-3	■ Charging with the optional BC-211	5-6
■ Panel description	1-4	■ Charging with the optional BC-218	5-7
■ Icons and indications	1-5	■ Insert the IP501H into the BC-218	5-7
■ About the key operations	1-6	■ Bluetooth® operation	5-8
■ Battery alert beep.....	1-7	■ HM-215/BC-218 description	5-10
■ Key Lock function.....	1-7	■ Charging VS-3	5-11
2. BASIC OPERATION	2-1	■ Pairing the IP501H with the BC-218 or VS-3	5-12
■ Transmitting and receiving	2-2	■ Connecting and disconnecting	5-15
■ Using the Address Book	2-4	■ Deleting a Bluetooth device from the pairing list	5-21
■ Using the Call history	2-5	■ Initializing the pairing list of the IP501H	5-22
3. ADVANCED OPERATION	3-1	■ Initializing the pairing list of the BC-218	5-23
■ Sending a message (Message Call).....	3-2	■ Initializing the pairing list of the VS-3	5-24
■ Viewing received messages	3-3	■ Installing the MBA-7/MBF-1 on a flat surface	5-25
■ Status Call.....	3-3	■ LC-185 (For BP-272)	5-28
■ About the Group (or Talkgroup) Call	3-4	■ When connecting optional equipment	5-29
■ Selecting a Talkgroup number with the [FUNC] key	3-5	6. FOR YOUR REFERENCE	6-1
■ Selecting a Talkgroup number with the [Address] key	3-5	■ Troubleshooting	6-2
■ About the [Option] key.....	3-6	■ Specifications	6-4
■ Recording	3-7		
■ Pocket Beep function	3-10		
■ P-Bell function	3-10		
■ About the VOX function	3-11		
■ Emergency Call function.....	3-12		
■ Lone Worker function	3-13		
■ Man Down function	3-13		
4. SET MODE	4-1		
■ Entering to the Basic Set mode	4-2		
■ Entering to the Advanced Set mode	4-2		
■ Operation in the Set mode	4-3		
■ Set mode item list	4-4		

■ Attaching the antenna.....	1-2
■ Attaching the hand strap.....	1-2
■ Attaching the belt clip	1-2
■ Attaching the battery pack	1-2
■ Turning ON the power/Adjusting the audio level	1-3
■ Panel description.....	1-4
■ Icons and indications.....	1-5
■ About the key operations.....	1-6
■ Battery alert beep	1-7
■ Key Lock function	1-7

1 BEFORE USING

■ Attaching the antenna

Hold this part to turn.

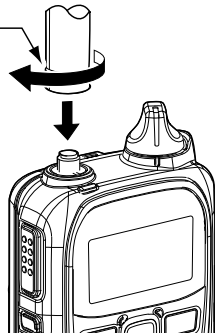

CAUTION:

- NEVER carry the transceiver by holding only the antenna.
- Transmitting without an antenna may damage the internal circuit.

NOTE: You can use only the supplied antenna.

■ Attaching the hand strap

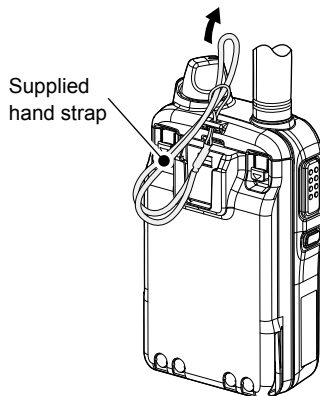

■ Attaching the belt clip

① Remove the battery pack before attaching or removing the belt clip.

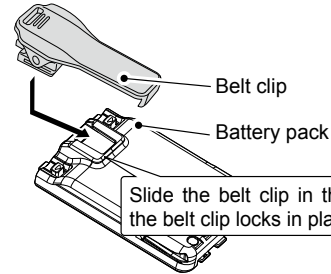

Slide the belt clip in the direction of the arrow until the belt clip locks in place, and makes a 'click' sound.

Removing the belt clip

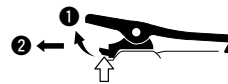

Lift the tab up ①, and slide the belt clip in the direction of the arrow ②.

■ Attaching the battery pack

Fully charge the battery pack before turning ON for the first time, or after 2 month or more of no use.

① Refer to Section 5 for charging information.

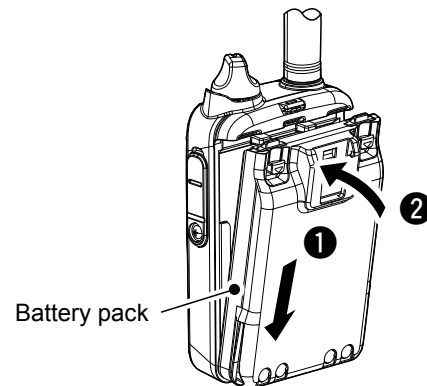

Follow the order ① ~ ② on the illustration above.

NOTE: After attaching, check that the battery pack is firmly attached. (2 sliding locks are in place.)

CAUTION

Even when the transceiver's power is OFF, a small current still flows in the transceiver. Remove the battery pack when not using it for a long time. Otherwise, the battery will become exhausted.

NOTE: Turn OFF the power before remove the battery pack in order ① ~ ② in the illustration to the right.

① Do not remove the battery pack until "POWER OFF..." is disappeared. Otherwise the recorded audio may be lost.

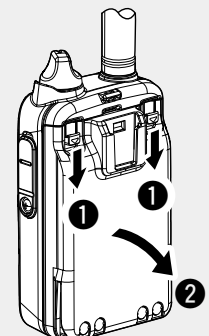

1 BEFORE USING

■ Turning ON the power/Adjusting the audio level

1 Turning ON the power

Turn [PWR/VOL] clockwise to the 12 o'clock position.
• A beep sounds.

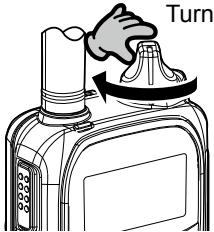

① The dial is made tight for the dust and water resistance.

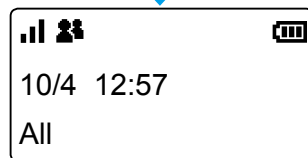
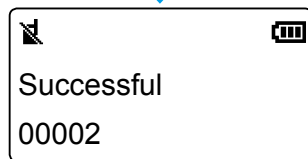
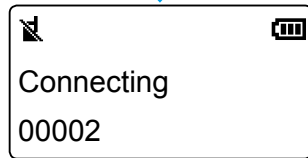
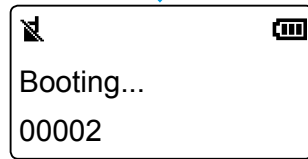
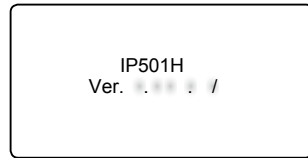

Standby screen

2 Adjusting the audio output level

Turn [PWR/VOL] to adjust the audio output level.
• The volume can be adjusted between 0 and 32.

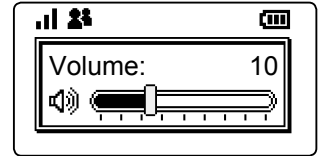
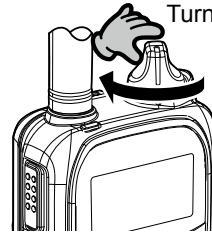

NOTE: If the output level is set to minimum, the beep does not sound.

The signal strength is represented by 3 bars.
In the 3G mode, the received signal strength is indicated by the icon. In the LTE mode, the icon is displayed.
① When the transceiver location is out of the service area, or cannot receive the control signal, the (out-of-area) icon blinks. If the IP501H has not been registered, is displayed.

1 BEFORE USING

■ Panel description

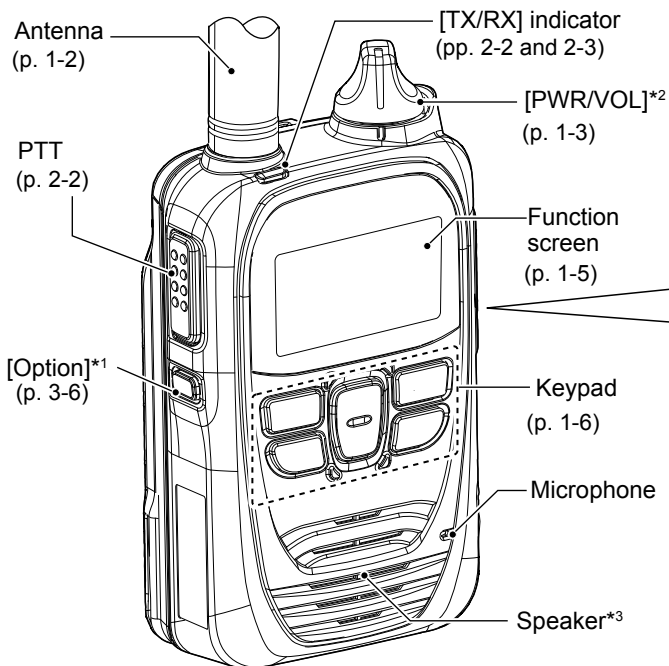

When connecting optional equipment

- Be sure to turn OFF the power before connecting or disconnecting optional equipment to or from the jack.
- Remove the cable by holding the plug, not the cable.
- Insert the plug securely when connecting the cable.

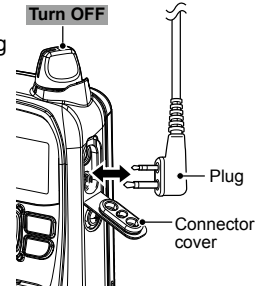

CAUTION:

Attach the jack cover when no optional equipment is connected.

NOTE: Instructions and screens on this guide may differ, depending on the settings.

*1 Ask for your dealer about the assigned function.

*2 When the Bluetooth function is used and the "Bluetooth Synchronous Volume" item is set to "Enable" (p. 4-6), the audio volume cannot be adjusted by [PWR/VOL] but [VOL] (+) or [VOL] (-) key on the Bluetooth device.

*3 While connecting an optional speaker microphone or the Bluetooth function (p. 5-8) is used, the audio is not output from the internal speaker.

1 BEFORE USING

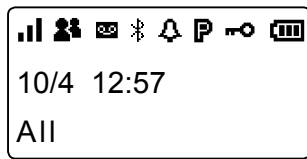

■ Icons and indications



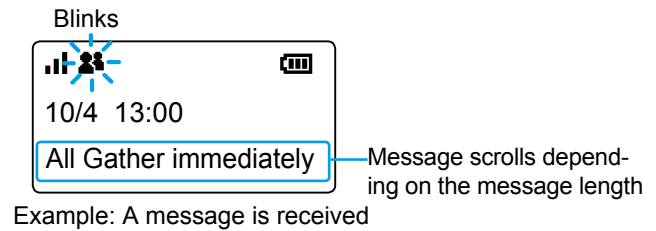



Standby screen



Signal strength

The signal strength is represented by 3 bars. When the transceiver location is out of the service area, or cannot receive the control signal, the  (out-of-area) icon blinks. If the IP501H has not been registered,  is displayed. (p. 1-3)

Call types*1

-  : All/Group Call
-  : Talkgroup Call*2 (p. 3-4)
-  : Individual Call
-  : Phone Call*3

*1Blinks when a call or message is received.
*2May be usable, depending on a presetting.
*3Feature in the near future.

 **Recording function** (p. 3-7)

 **Bluetooth function** (p. 5-8)

 **Pocket beep** (p. 3-10)

 **P-Bell function** (p. 3-10)

 **Lock function** (p. 1-7)

 **Remaining battery capacity**

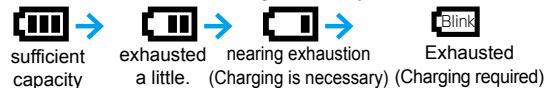

Represents the remaining capacity in 4 steps.

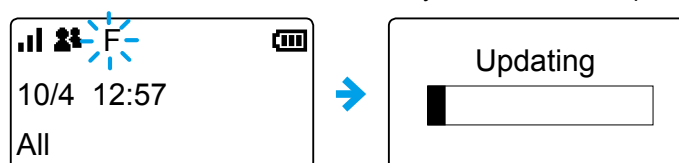

“F” blinks while downloading a new firmware:

- Do not turn OFF the transceiver until the download is finished. Place the transceiver in a good signal level area. Downloading takes approximately 10 minutes.
- After the downloading is finished, the firmware update will start. Updating takes approximately 1 minute.
- Do not turn OFF the transceiver. The transceiver will automatically restart when the update is finished.



- If "F" has been displayed for more than 10 minutes, reboot the transceiver.
- If the battery status indication is  (nearing exhaustion) or  (exhausted), the firmware update will not start. Charge the battery pack, then restart the IP501H and do the firmware update.

1 BEFORE USING

■ About the key operations

[Address] key*



Selects a calling party or group from this list. Push [▲]/[▼] to select "All Call," "Group Call" or "Individual Call."

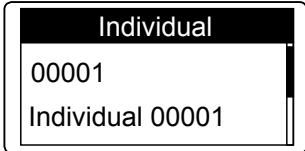

Address book: Individual

[Call history] key*



Selects the call history.

Push [▲]/[▼] to select the "TX log," "RX log," "TX MSG log," "RX MSG log," "TX TEL log" or "RX TEL log."

- Hold down until "Emergency" is displayed to send an emergency call, depending on a presetting.

[▲]/[▼] key



Push to scroll the screen, or move the cursor.

[FUNC] key*



Selects the message, Status or Talk group to send.

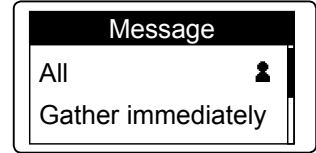

(Example: A message is selected.)

[CLR/LOCK] key



Push to return to the previous screen from a function screen. Hold down for 1 second to turn the Key Lock function ON or OFF.

- ① [PTT] switch and [PWR/VOL] dial can be used, even while the Key Lock function is ON.

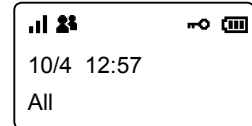

(Example: Key Lock function is ON.)

*May be usable, depending on a presetting.

1 BEFORE USING

■ Battery alert beep

When the battery is almost exhausted, the battery status indicator “” starts blinking, and warning beeps sound every 30 seconds. Charge the battery pack immediately. (Section 5)

When the battery is nearly exhaustion:

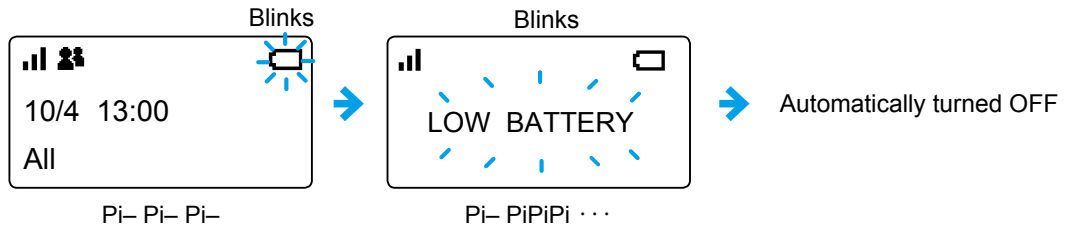

① When “LOW BATTERY” is displayed and beeps sound, the transceiver power will be automatically turned OFF soon.

■ Key Lock function

The Key Lock function prevents accidental function access.

① An Emergency call (p. 3-12) can be made, even while the Key Lock function is ON.

- Hold down [CLR/LOCK] for 1 second.
- A beep (Pi, Pi) sounds and “” appears.
 - ① Hold down [CLR/LOCK] for 1 second to cancel the function.
 - ① [PTT] and [PWR/VOL] are functional even while the Key Lock function is ON.



Standby screen

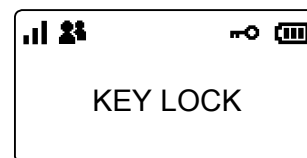

When a key is pushed while the Key Lock function is ON.

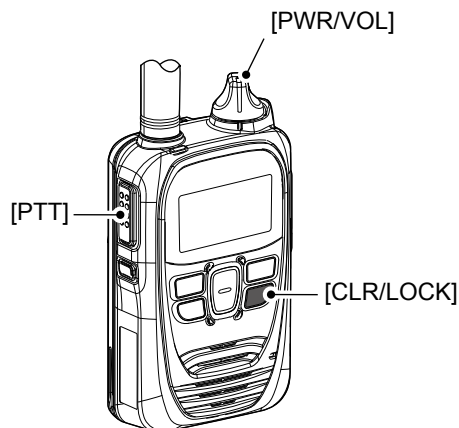

■ Transmitting and receiving	2-2
■ Using the Address Book	2-4
■ Using the Call history	2-5

2 BASIC OPERATION

■ Transmitting and receiving

1 Hold down [PTT]

While holding down [PTT], speak into the microphone at your normal voice level.

- The [TX/RX] indicator lights red while [PTT] is pushed.

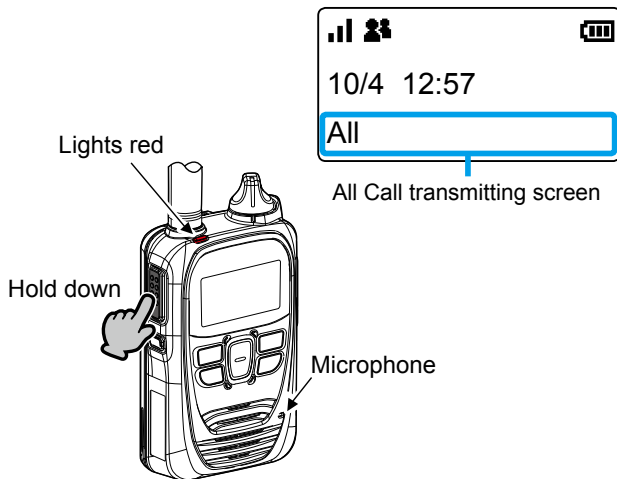

2 Receive a call

When a Call is received, the received audio is heard.

- [TX/RX] indicator lights green while receiving.

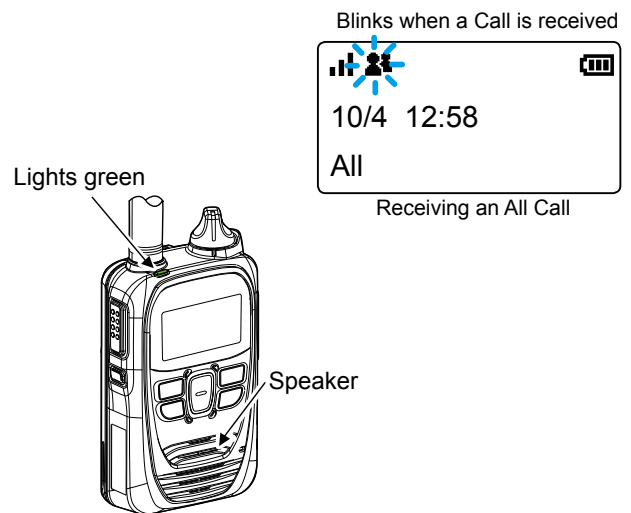

Calling tip:

Hold the transceiver 2.5 inch away from your mouth, and speak at your normal voice level. Talking too close to the microphone, or in a loud voice can distort your voice.

About the Time-out Timer:

When the continuous transmission period exceeds 5 minutes, the Time-out Timer automatically stops the transmission to prevent prolonged transmissions. Release the PTT, then hold down again to resume talking.

About the key touch beep:

Depending on a preset, a confirmation beep sounds when you push a key. (p. 4-5)

About the alert:

Depending on a preset, the alert that notifies the out of the service area or receive status sounds. (p. 4-5)

About the Vibration function:

Depending on a preset, the Vibration function indicates that a call is received. (p. 4-4)

2 BASIC OPERATION

■ Transmitting and receiving (continued)

3 Talk while receiving a call

While receiving a call, push [PTT] to talk in the full duplex mode* like a telephone call.

- ① In the Full Duplex mode, the [TX/RX] indicator lights orange.
- ① Turn [PWR/VOL] to adjust the audio output level. Do not cover the speaker or microphone.

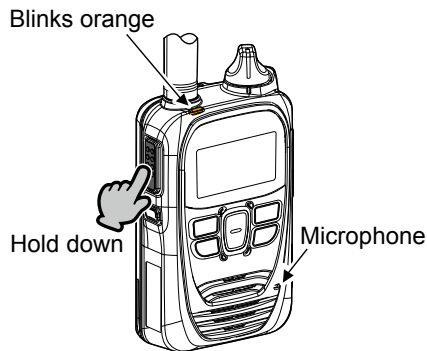

*Depending on a preset. Ask your dealer for details.

Turning OFF the power:

Turn [PWR/VOL] maximum counter clockwise until it makes a "click" sound.

- ① Wait for 10 seconds before you turn ON the transceiver again.
- ① Before you remove the battery pack from the transceiver, be sure that the transceiver power is OFF (The LCD is blank). (p. 1-2)

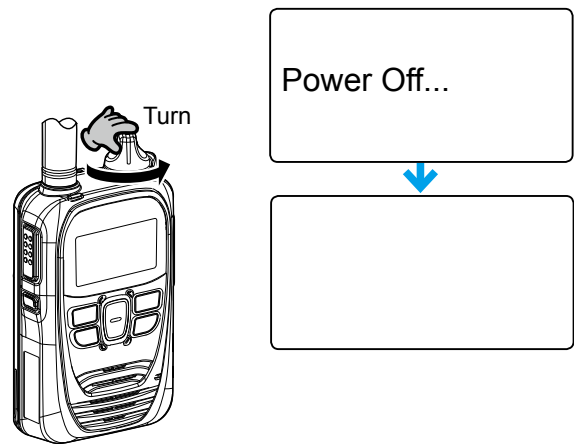

About the Simplex mode:

If the communication mode is set to Simplex by your dealer, you have to take turns to communicate: Push PTT to talk, release to receive.

- ① Push PTT after the other person finishes talking.
- ① Saying "Over" at the end of your talk makes the communication smooth.

About the Back Light function:

Depending on a preset, the Back Light function operation differs. (p. 4-5)

- Always OFF: Does not light.
- Always ON: Is always lit.
- On operation: When a Call is received or a key (except [PTT] and [PWR/VPL]) is pushed, the Back Light lights, then automatically turns OFF after 5 seconds.

NOTE: When using the Audio Recording function

The recorded audio is stored into the internal memory on power OFF. Do not remove the battery pack until "POWER OFF..." is disappeared. Otherwise the recorded audio may be lost.

2 BASIC OPERATION

■ Using the Address Book

The [Address] key can be used, depending on a preset. Ask your dealer for details.

1 Select a call-to party from the Address book

1. Push [Address] to select a Call type. (Example: Group call)
① Push this key several times to select "All," "Group (Talkgroup)," "Individual" or "Phone*."
② See page 3-4 about the Talk Group.
2. Push [▲]/[▼] to select a call-to party. (Example: Sales group 10)

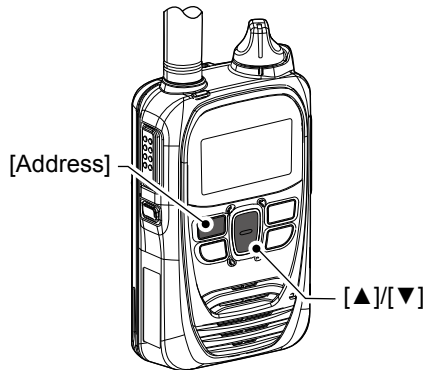

*Feature in the near future.

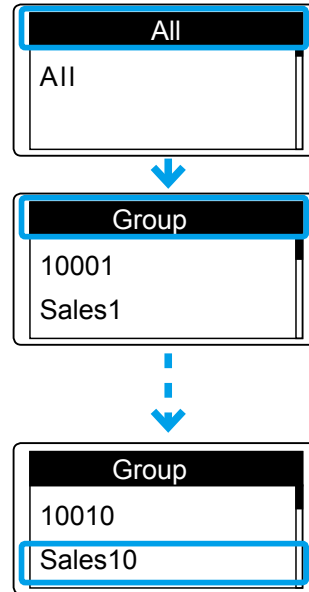

About the All or Group (Talkgroup) call:

Ask your dealer for details for call type setting.

2 Hold down [PTT]

While holding down [PTT], speak into the microphone.

- The [TX/RX] indicator lights red.

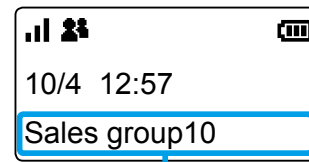
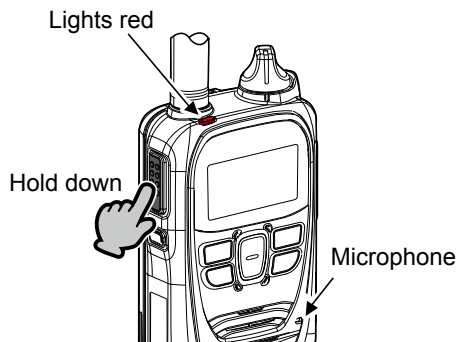

Address book: Group

2 BASIC OPERATION

■ Using the Call history

The [Call history] key can be used, depending on a preset. Ask your dealer for details.

1 Select a call-to party from the Call history

1. Push [Call history] to select a call history ("RX log").
① Push this key several times to select "TX log," "RX log," "TX MSG log," "RX MSG log," "TX TEL log" or "RX TEL log."
2. Push [▲]/[▼] to select a call-to party. (Example: Sales 8)

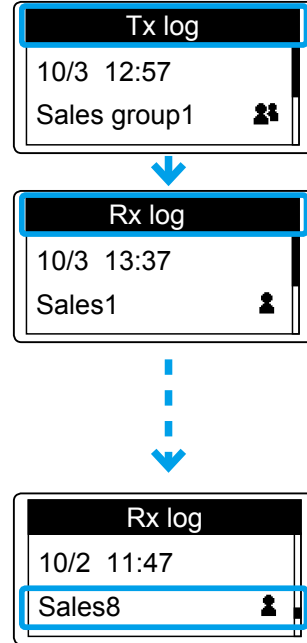
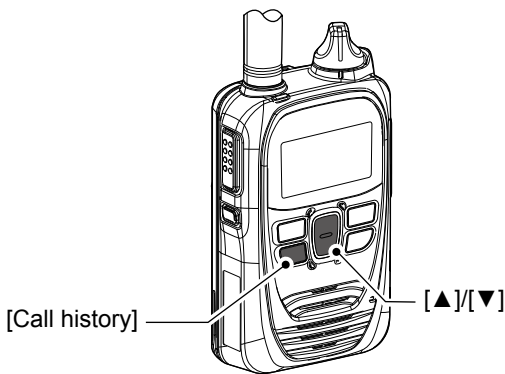

About the history log:

Up to 10 logs can be stored. The oldest log is automatically deleted when the 11th call is received.

2 Hold down [PTT]

While holding down [PTT], speak into the microphone.

- The [TX/RX] indicator lights red.

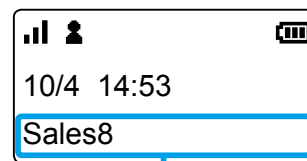
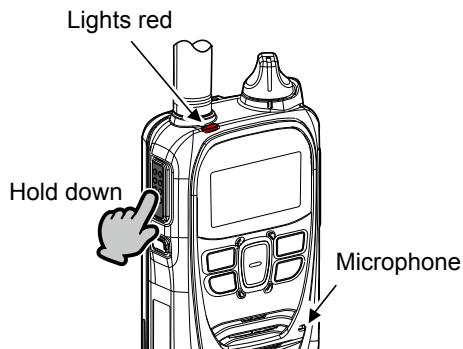

Individual call transmitting screen

2 BASIC OPERATION

■ Using the Call history (continued)

Deleting history logs:

1. While holding down [FUNC], turn ON the power.
2. Release [FUNC] when "SET" is displayed.
3. Push [FUNC] or [Address] several times to select "LOG."
4. Push [▲]/[▼] to select "CLR," then push [Call history].
 - All the histories except the recorded audio are deleted.
 - ① See page 3-9 for deleting the recorded audio.

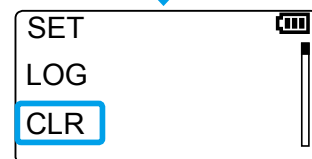
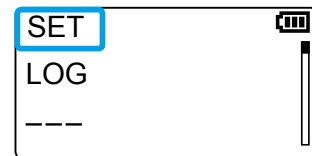
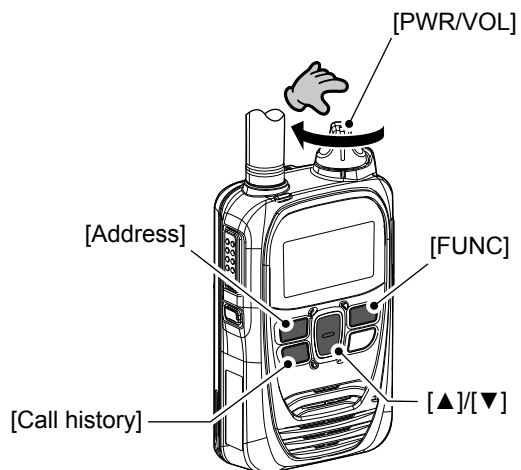

■ Sending a message (Message Call)	3-2
■ Viewing received messages.....	3-3
■ Status Call.....	3-3
■ About the Group (or Talkgroup) Call.....	3-4
■ Selecting a Talkgroup number with the [FUNC] key.....	3-5
■ Selecting a Talkgroup number with the [Address] key.....	3-5
■ About the [Option] key.....	3-6
■ Recording.....	3-7
■ Pocket Beep function	3-10
■ P-Bell function	3-10
■ About the VOX function.....	3-11
■ Emergency Call function	3-12
■ Lone Worker function	3-13
■ Man Down function.....	3-13

3 ADVANCED OPERATION

■ Sending a message (Message Call)

This function may be used, depending on a presetting. Ask your dealer for details.

1 Select a call-to party

1. Push [Address] to select a Call type. (Example: Individual)
 - ① Push this key several times to select "All," "Group (Talkgroup)," "Individual" or "Phone*."
 - ① See page 3-4 about the Talkgroup.
2. Push [▲]/[▼] to select the call-to party to send the message to. (Example: Sales2)

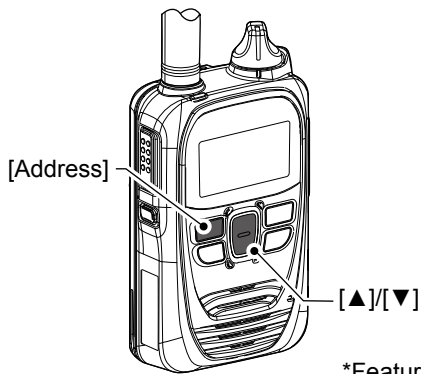

*Feature in the near future.

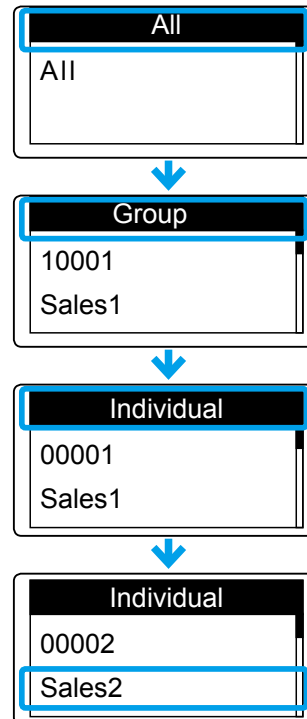

① You can select the call-to party also from the Call history (p. 2-5).

2 Select a message

1. Push [FUNC] to select "Message."
2. Push [▲]/[▼] to select a message.
 - The selected message may scroll, depending on the message length.
3. Push [PTT].

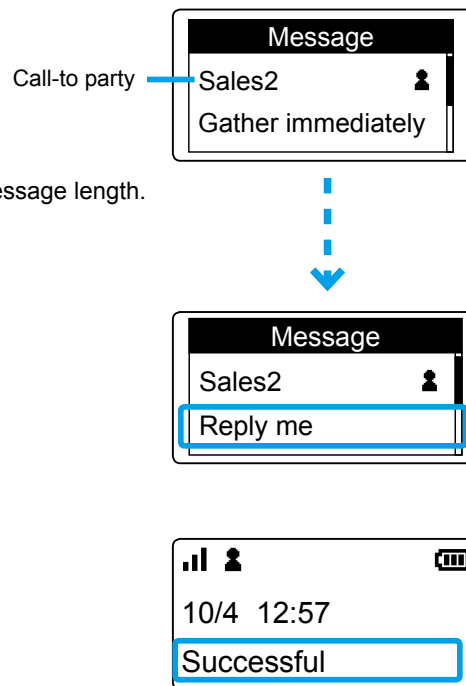
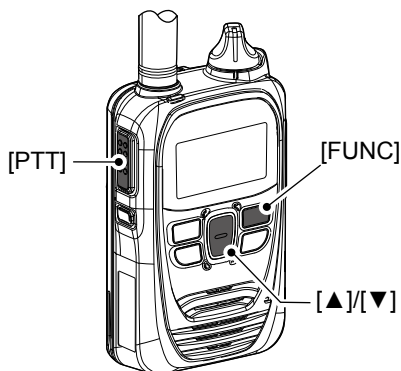

① When the Call type is set to "Individual," the call result (Success/Failed) is displayed after sending.

3 ADVANCED OPERATION

■ Viewing received messages

This function may be used only when the Talkgroup Call function is assigned to the [Call history] key. Ask your dealer for details.

1. Push [Call history] to select "Rx MSG log."
2. Push [▲]/[▼] to browse the message on the screen.
 - The selected message may scroll, depending on the message length.

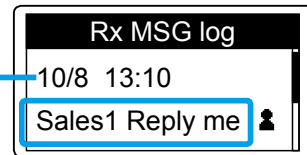
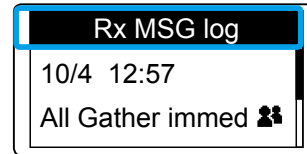
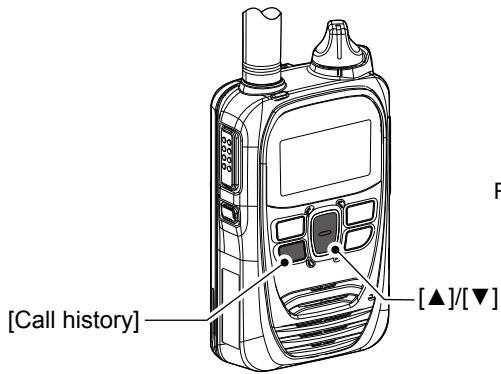

Received date and time

The Sender and Received message are displayed

■ Status Call

This function may be used only when the Status function is assigned to [FUNC], and the status (Example: "Meeting," "Break," and so on) is set. Ask your dealer for details.

1. Push [FUNC] to select "Status."
2. Push [▲]/[▼] several times to select a status.
3. Push [PTT] to transmit.

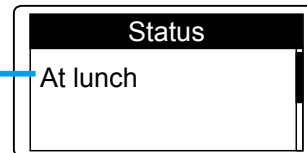
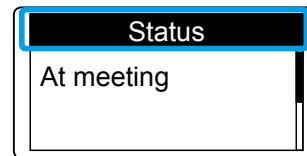
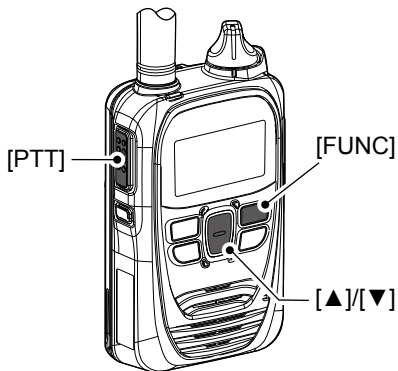

Selected status

3 ADVANCED OPERATION

■ About the Group (or Talkgroup) Call

The Talkgroup Call function enables the user to communicate with call-to parties in the same Talkgroup.

For example, in the illustration below, when IP501H "00004" in its normal group "10001," it is excluded from group "10001," and can communicate with only IP501Hs "00006" and "00008" that belong to group "20001."

① This function may be used only when the Talkgroup number is registered and the Talkgroup Call function is assigned to a key by your dealer.

② Ask your dealer about whether or not to include the Talkgroup in the All Call.

When Talkgroup is OFF

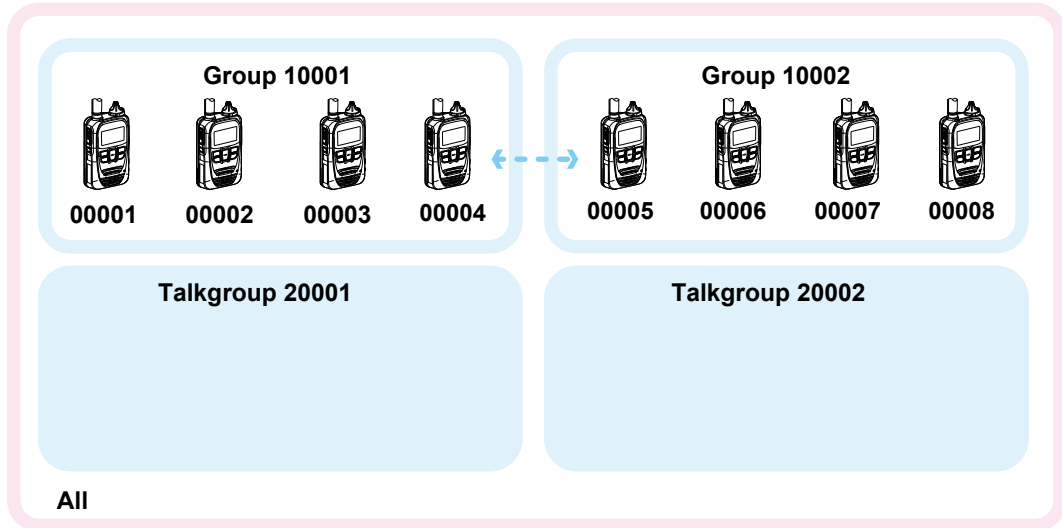

When Talkgroup is selected

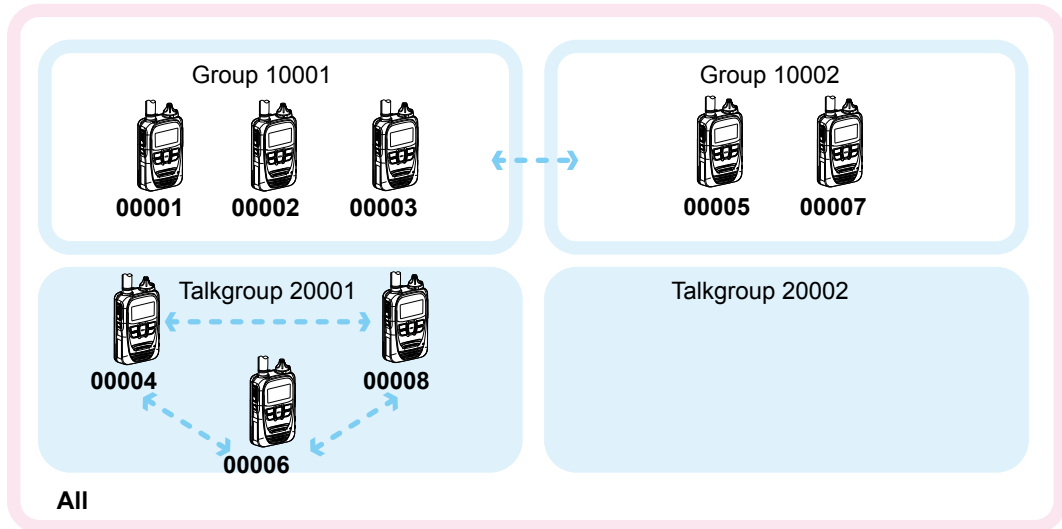

3 ADVANCED OPERATION

■ Selecting a Talkgroup number with the [FUNC] key

This function may be used only when the Talkgroup Call function is assigned to the [FUNC] key. Ask your dealer for details.

1. Push [FUNC] to select "Talkgroup."
2. Push [▲]/[▼] to select a Talkgroup number you want to belong to. (Example: 20001)
3. Push [CLR/LOCK].
 - The transceiver is ready to talk to only the transceivers that belong to the same Talkgroup.
 - ① While the Talkgroup number is selected, the Normal Group call cannot be made. (p. 3-4)
 - ② You can leave the Talkgroup and return to the Normal Group by selecting "OFF" in Step 2 on the "Talkgroup" screen.

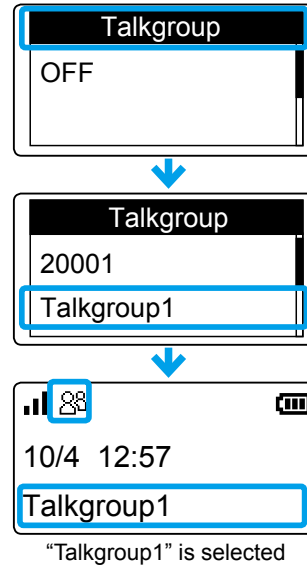
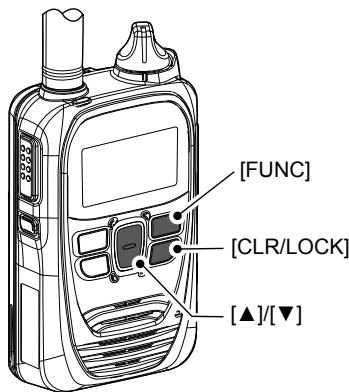

■ Selecting a Talkgroup number with the [Address] key

This function may be used only when the Talkgroup Call function is assigned to [Address] key. Ask your dealer for details.

1. Push [Address] to select "Group."
 - Each push changes the Call type.
2. Push [▲]/[▼] to select a Talkgroup number you want to belong to. (Example: 20001)
3. Push [CLR/LOCK].
 - The transceiver is ready to talk to only the transceivers that belong to the same Talkgroup.
 - ① While the Talkgroup is selected, the Normal Group call cannot be made. (p. 3-4)
 - ② You can leave the Talkgroup and return to the Normal Group by selecting "OFF" in step 2 on the "Talkgroup" screen.

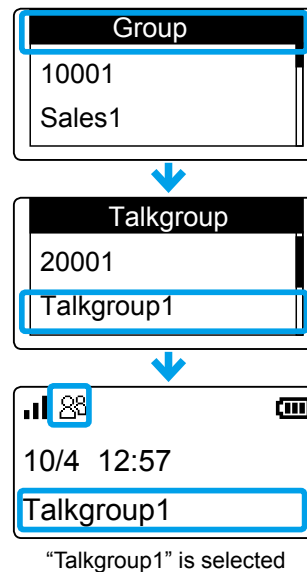
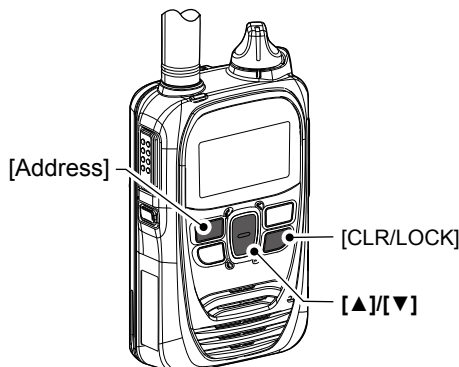

3 ADVANCED OPERATION

■ About the [Option] key

One of the following functions may be assigned to the [Option] key by your dealer. Ask your dealer for details.

ASSIGNABLE FUNCTIONS:

Message	Selects an often used message.
One touch	Selects the often used Call type or Call-to party.
Clear Down	Hangs up a Telephone call*. ⓘ You can cancel the call by pushing [Option] again. ⓘ The IP501H can terminate the Telephone call when: <ul style="list-style-type: none"> • The call type is "Individual" and the call was initiated by the telephone. • The call is initiated by the IP501H.
Mute	Mutes or unmutes the received audio. (The notification tone is not muted.) <ul style="list-style-type: none"> • Hold down [Option] for 1 second. ⓘ Pushing [PTT] also releases the mute.
Playbacks	Plays back the recorded audio.
Emergency	Transmits an Emergency call. <ul style="list-style-type: none"> • Hold down [Option] until "Emergency" is displayed. ⓘ The Emergency call is cancelled when: <ul style="list-style-type: none"> • A call is received. • You hold down [Option] until "Emergency" disappears. • The transceiver power is turned OFF. • The time set in the "Cancel by Time" item has elapsed.

*Feature in the near future.

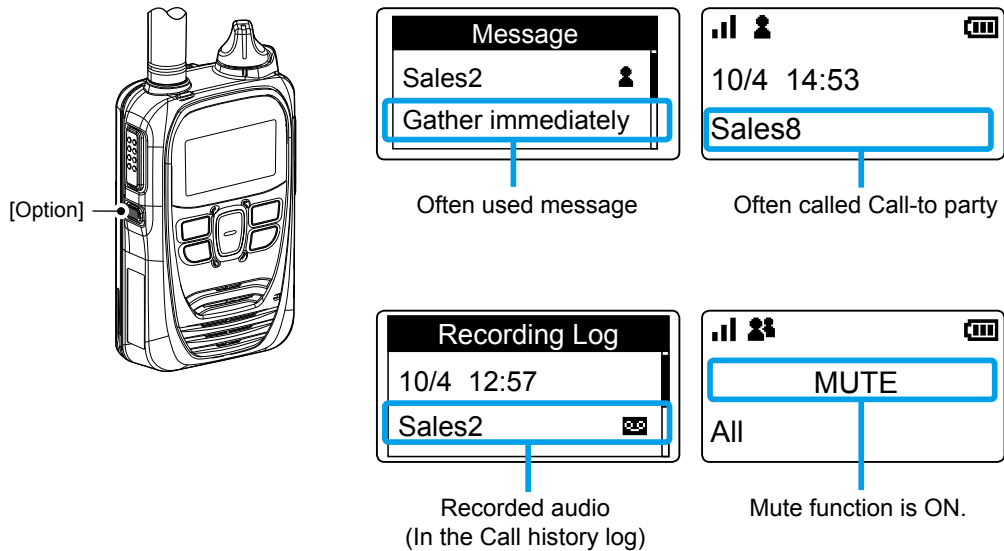

3 ADVANCED OPERATION

■ Recording

The Recording function records the audio of received calls.

The recording duration of a single file is up to 1 minute. The oldest file will be automatically overwritten when the 5th call is recorded.

① You can play the recorded audio only when the Playback function is assigned to [Option] by your dealer.

① As the default setting, you can record only Individual calls. You can change this setting in the Set mode (p. 4-7).

① Only the call-to party's voice is recorded.

① The recorded audio data cannot be exported.

NOTE: When removing the battery pack

The recorded audio is stored in memory on Power OFF. Do not remove the battery pack until "POWER OFF..." is disappeared. Otherwise the recorded audio may be lost.

1. Setting the Recording function enable

1. While holding down [FUNC], turn ON the power.
 - Enter the Set mode.
2. Release [FUNC] when "SET" is displayed.
3. Push [FUNC] or [Address] several times to select "Recording."
4. Push [▲]/[▼] to select "Enable."
5. Push [CLR/LOCK].
 - Exits the Set mode.

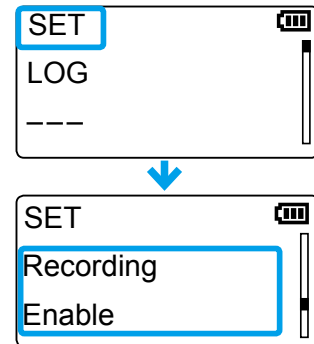
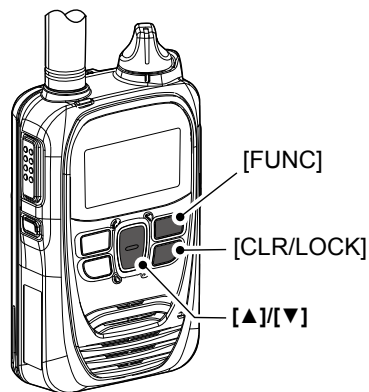

3 ADVANCED OPERATION

■ Recording (continued)

2. Turning ON the Recording mode

1. Push [FUNC] to select "Recording."
2. Push [▲]/[▼] to select "ON."
3. Push [CLR/LOCK].
 - The Recording mode is ON, and the Recording mode icon is displayed.
 - The icon blinks when there is a recorded audio that has not been played yet.

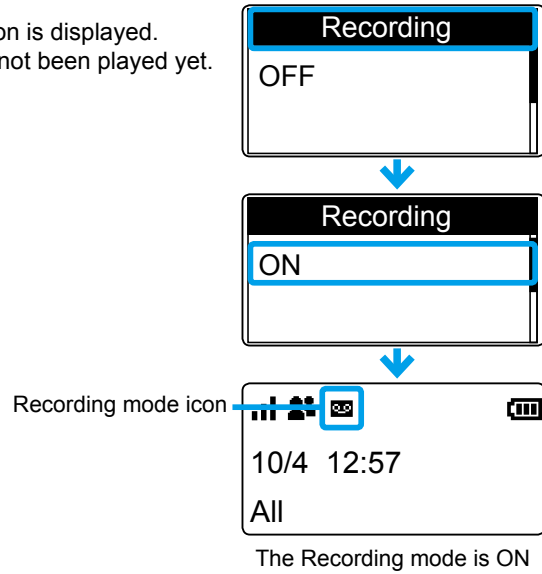
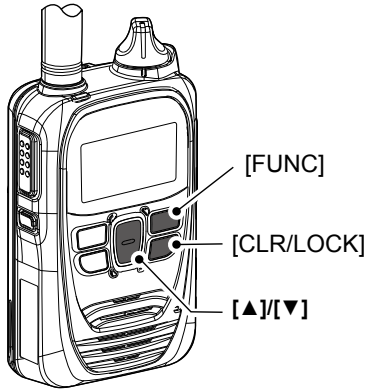

3. Playing the recorded audio

1. Push [Call history] several times to select "Recording log."
2. Push [▲]/[▼] several times to select the recorded audio to play.
3. Push [Option].
 - The selected record audio is played.
 - Push [Option] to stop playing.

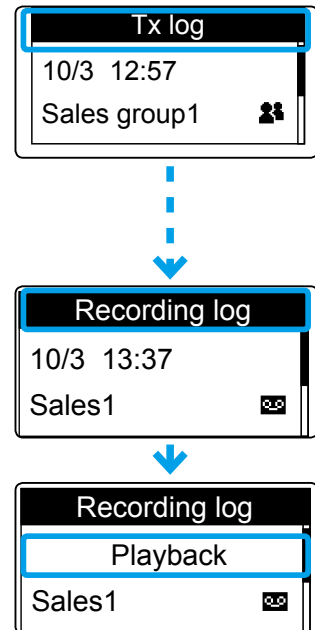
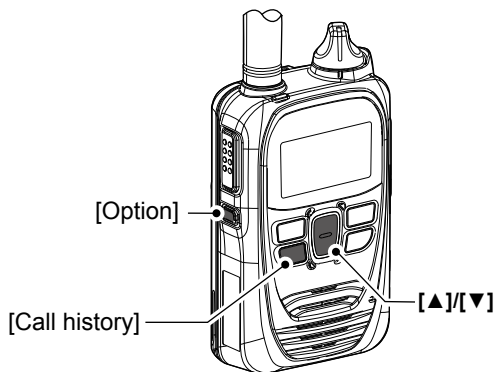

3 ADVANCED OPERATION

■ Recording (continued)

4. Deleting all the recorded audio history

1. While holding down [FUNC], turn ON the power.
 - Enter the Set mode.
2. Release [FUNC] when “SET” is displayed.
3. Push [FUNC] several times to select “Delete Record Audio.”
4. Push [▲]/[▼] to select “CLR.”
5. Push [Call history].
 - Exits the Set mode.

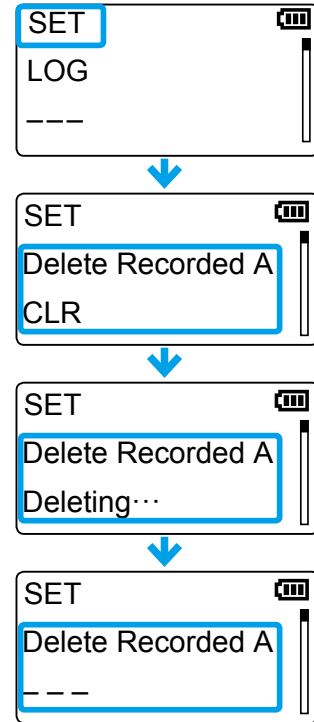
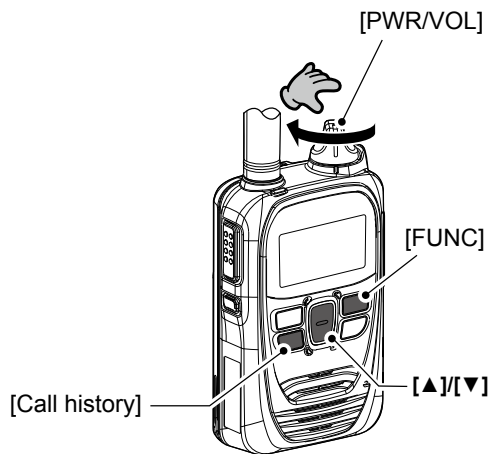

3 ADVANCED OPERATION

■ Pocket Beep function

The Pocket beep function sounds a notification tone and indication when a call is received.

① This function is set by your dealer, or in the Set mode.
(p. 4-4)

① When the Pocket Beep function is ON, “🔔” is displayed.

- When a call is received, the notification beep sounds and “🔔” blinks.

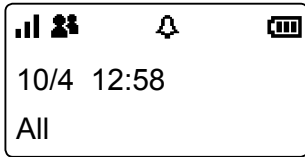

Standby screen

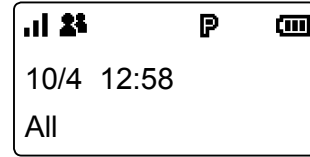

Standby screen

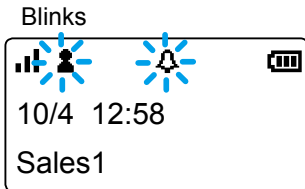

When an Individual call is received

■ P-Bell function

The P-Bell function sounds the notification tone when a call is received.

The **P** icon is displayed when the P-Bell function is used.

① This function is set by your dealer, or in the Set mode.
(p. 4-4)

- ① You cannot listen to the call until you reply to the call. After pushing [PTT] on the IP501H, the mute is released.

3 ADVANCED OPERATION

■ About the VOX function

The VOX function automatically switches between receive and transmit during voice operation.

When the VOX function is ON, speak into the headset microphone to transmit, then stop speaking to listen. In full-duplex, you can speak and listen to the call-to party at the same time.

To use this function, an optional headset and a VOX converter cable, shown below are required.

① This function is set by your dealer.

① You can configure the setting in the Set mode. (p. 4-5)

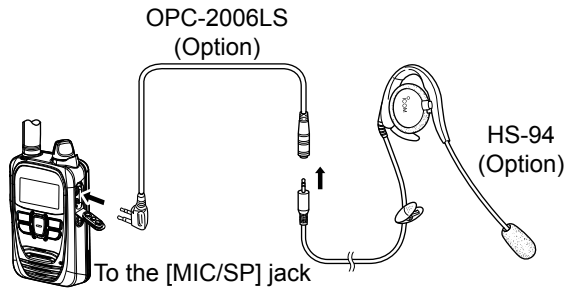

NOTE:

Be sure to turn OFF the power before connecting or disconnecting optional equipment to or from the jack.

- Remove the cable by holding the plug not cable.
- Insert the plug securely when connecting the cable.
- Attach the jack cover when no optional equipment is connected.

① The jack is made tight to resist dust and water intrusion.

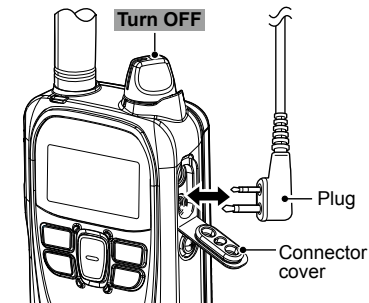

Attaching an optional equipment

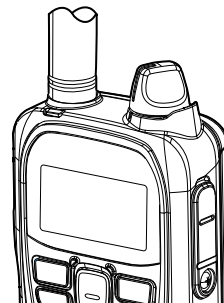

Jack cover is attached

3 ADVANCED OPERATION

■ Emergency Call function

The Emergency Call function may be assigned to the [Option] or [Call history] key by your dealer. Ask your dealer about the assigned function.

Transmitting an Emergency call:

1. Hold down [Option] or [Call history] until "Emergency" is displayed.
 - An alarm sounds periodically.
 - ① When the Silent mode is set to "ON" by your dealer, no alarm sounds, and no emergency indication is displayed.
2. Wait for the answer back.
 - When the IP501H receives an answer back, the alarm stops, and the [TX/RX] indicator lights green.
 - ① To cancel the emergency call, hold down [Option] until "Emergency" disappears, or turn OFF the transceiver.

When an Emergency call is received:

1. "Emergency" is displayed and the alarm periodically sounds.
 - ① When the Silent mode is set to "ON" by your dealer, no alarm sounds.
2. While holding down [PTT], talk into the microphone.
 - While holding down [PTT], the [TX/RX] indicator lights red.
 - The alarm stops.
 - Returns to the normal mode when PTT is released.

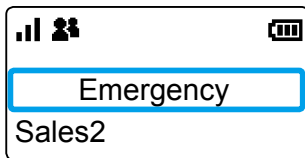

Emergency screen

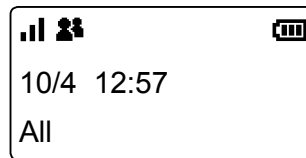

Emergency screen in the Silent mode

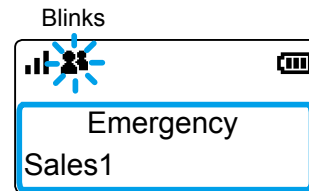

When an Emergency call is received

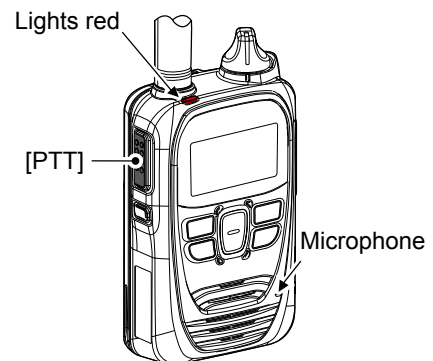
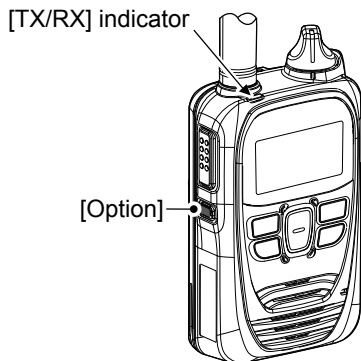

NOTE:

Icom is not responsible for the destruction or damage caused by using the Emergency Call function.

This function may not properly work under the following circumstances or conditions:

- Remaining battery capacity is low.
- Surrounding area or environment.
- The Emergency function is not designed for secured communications.

3 ADVANCED OPERATION

■ Lone Worker function

When the Lone Worker function is activated, the Emergency function (p. 3-12) is automatically turned ON after the IP501H has been left without any operation for the specified time period.

To reset the timer, operate any key or the volume control within the specified time period.

① This function may be used only when the Lone Worker function is programmed by your dealer.

■ Man Down function

When the Man Down function is activated, the Emergency function (p. 3-12) is automatically turned ON after the set period of time has passed with the IP501H leaning past the preset angle.

To reset the timer, raise back the transceiver from the preset angle towards the vertical position within this set time period.

① This function may be used only when the Man Down function is programmed by your dealer.

NOTE:

Icom is not responsible for the destruction or damage caused by using the Lone Worker or Man Down function.

These functions may not properly work, depending on the following circumstances or conditions:

- Remaining battery capacity is low.
- Surrounding area or environment.
- The Lone Worker and Man Down function are not designed for secured communications.

■ Entering to the Basic Set mode.....	4-2
■ Entering to the Advanced Set mode.....	4-2
■ Operation in the Set mode	4-3
■ Set mode item list.....	4-4

4 SET MODE

There are 2 types of Set mode: Basic and Advanced.

■ Entering to the Basic Set mode

You cannot transmit nor receive while the transceiver is in the Set mode.

1. While holding down [FUNC], turn ON the power.
2. Release [FUNC] when "SET" is displayed.

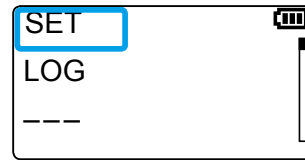
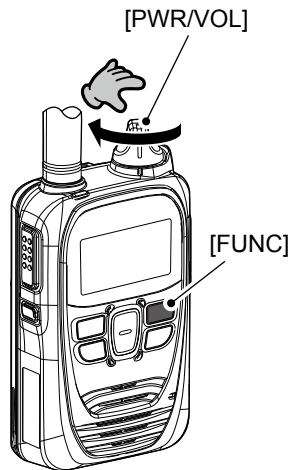

■ Entering to the Advanced Set mode

You cannot transmit or receive while the transceiver is in the Set mode.

1. While holding down [FUNC] and [Address], turn ON the power.
2. Release both keys when "SET" is displayed.

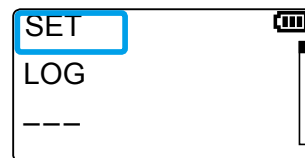
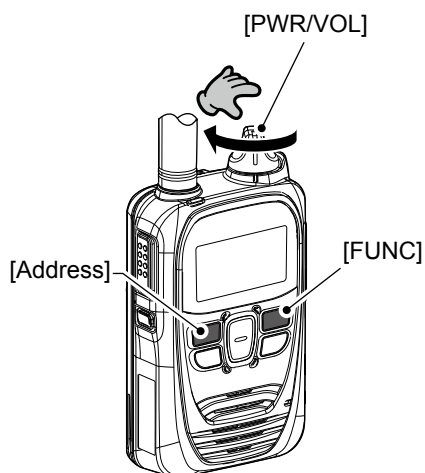

4 SET MODE

■ Operation in the Set mode

1. Push [FUNC] or [Address] to select an item.
2. Push [▲]/[▼] to set the value.
3. Push [PTT] or [CLR/LOCK] to save the value and exit the Set mode.

- Push [Call history] to execute the following functions.
 - LOG
 - RESET*
 - FIRM UP*
 - Delete Recorded Audio
 - Delete Bluetooth Device
 - Search Bluetooth Device
 - Initialize Bluetooth Unit

*After performing these functions, IP501H automatically restarts.

① Updating the firmware takes approximately 10 minutes.

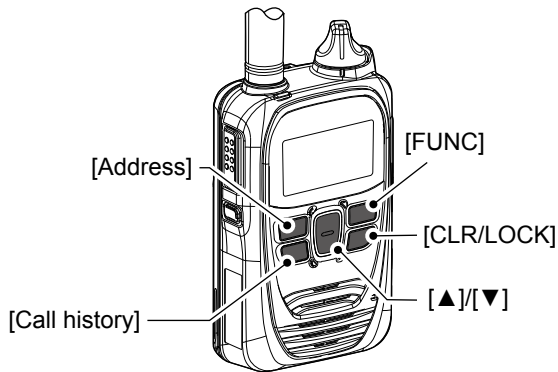

Example: Setting the Key-Touch Beep Volume

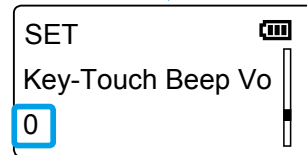
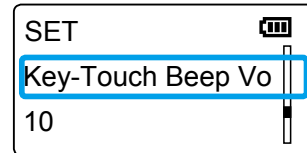
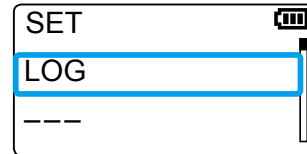

Setting the Key Touch Beep Volume to "0"

Example: Updating the firmware

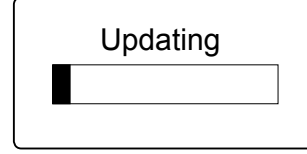
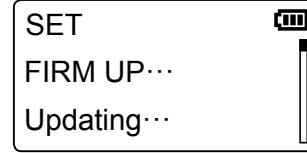
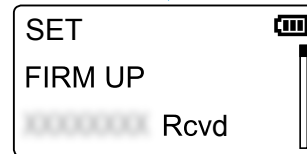
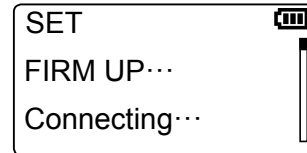
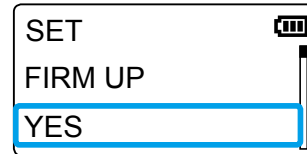

Updating the firmware

4 SET MODE

■ Set mode item list

The shaded items (■) are also displayed in the Basic Set mode.

① Items or default values may differ according to a presetting. Ask your dealer for details.

Item	Description	Option/Range	Default
LOG	Deletes logs.	---, CLR (Clear)	---
Reset	Initializes the IP501H. Returns to the default values except the Bluetooth pairing list.	NO or YES	NO
FIRM UP	Updates the firmware.	NO or YES	NO
Success Tone	Sets the successful tone for Individual calls. ① The success or failure result is also displayed on the screen.	Disable or Enable	Enable
Failure Tone	Sets the failure tone for Individual calls ① The success or failure result is also displayed on the screen.	Disable or Enable	Enable
Calling Notice Tone (Individual Call)	Sets the call initiation tone.	Disable, Tone1 ~ Tone8 ① Larger number makes the tone lower.	Tone1 (Pi)
Calling Notice Tone (Group Call)			
Calling Notice Tone (All Call)			
Calling Notice Tone (Telephone*)			
Courtesy Beep (Individual Call)	Sets the call termination tone.	Disable, Tone1 ~ Tone8 ① Larger number makes the tone lower.	Tone1 (Pi)
Courtesy Beep (Group Call)			
Courtesy Beep (All Call)			
Courtesy Beep (Telephone*)			
Receive Notification Tone (Individual Call)	Sets the call receive tone.	Disable, Tone1 ~ Tone8 ① Larger number makes the tone lower.	Disable
Receive Notification Tone (Group Call)			
Receive Notification Tone (All Call)			
Receive Notification Tone (Telephone*)			
Receive Notification Tone (Message)			
Notification Type (Individual Call)	Sets the call receive notification type.	Pocket beep or P-Bell	P-Bell
Notification Type (Group Call)			
Notification Type (All Call)			
Notification Type (Telephone*)			
Number of Notifications (Individual Call)	Sets the number of tone.	Continuous, 1, 3, 10, 20 (times)	3 (times)
Number of Notifications (Group Call)			
Number of Notifications (All Call)			
Number of Notifications (Telephone*)			
Number of Notifications (Message)			
Received Call Notification Action	Sets the call or message receive notification type.	Tone, Vibration, Notification Beep + Vibration	Tone
Received Call Notification Volume	Sets the call or message receive notification volume.	0 ~ 32	10

*Feature in the near future.

4 SET MODE

■ Setting item list (continued)

The shaded items (■) are also displayed in the Basic Set mode.

①Items or default values may differ according to a presetting. Ask your dealer for details.

Item	Description	Option/range	Default
Out of Range Notice Tone	Sounds the out-of-area warning beep. The beep also sounds when the transceiver reenters the service area. (Out-of-area: "Pipi," Reenters: "Popo")	Disable or Enable	Disable
Stop Sidetone in Out of Range	Mutes the sidetone when the transceiver is out-of-area.	Disable or Enable	Disable
Sidetone	The Sidetone function outputs the transmitting audio to a headset that is connected to the transceiver. When this item is set to "Enable," the Echo Canceller function is automatically set to "Disable."	Disable or Enable	Disable
Sidetone Volume	Sets the Side tone volume.	0 ~ 32	10
VOX	Automatically switches between receive and transmit by detecting your voice.	Disable, earphone-microphone or headset	Disable
VOX Threshold	Sets the VOX gain level. ①Higher values make the VOX function more sensitive to your voice.	0% ~ 100%	40%
Echo Canceller	Sets the Echo Cancelling function. (commonly used for an earphone MIC and headset) When the "SideTone" item is set to "Enable," this item is fixed to "Disable."	Disable or Enable	Enable
Noise Canceller	Sets the Noise Cancelling function. (commonly used for an IP501H, earphone MIC and headset)	Disable or Enable	Enable
BackLight	Sets the backlight operating function.	Auto, OFF or ON	Auto
Contrast	Sets the screen contrast.	1 (lowest) ~ 16 (highest)	8
Mic Gain	Sets the microphone sensitivity. ①Higher values make the microphone more sensitive to your voice.	-12 dB (lowest) ~ 12 dB (highest) (in 3 dB step)	0 dB
Notification Beep Volume	Sets the notification beep level.	0 ~ 32	10
Key-Touch Beep	Sets the Key-touch beep.	Disable or Enable	Enable
Key-Touch Beep Volume	Sets the Key-touch beep level.	0 ~ 32	10
Receive Buffer Type	Sets the Jitter buffer size. ①Jitter buffer reduces audio interruptions.	Dynamic, 40 ~ 480 milliseconds (in 40 milliseconds step)	Dynamic
Tx Inhibit	Inhibits transmission. Select "Enable" to lock all the controls except [PWR/VOL]. ①Transmission is also inhibited while using an external microphone, and the VOX function.	Disable or Enable	Disable
PTT Lock	Inhibits transmission by the internal PTT.	Disable or Enable	Disable
PTT Call at Stand-by	Displays the call-to party (Call type) on the standby screen.	Disable or Enable	Enable

4 SET MODE

■ Setting item list (continued)

The shaded items (■) are also displayed in the Basic Set mode.

①Items or default values may differ according to a presetting. Ask your dealer for details.

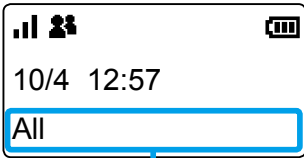
Item	Description	Option/range	Default
One Touch PTT	Toggles receiving and transmitting by momentarily pushing [PTT]. Push [PTT] to talk, then push again to return to receive. ①When "Enable" is selected, "One Touch PTT" is displayed when [FUNC] is pushed.	Disable or Enable	Disable
Destination ID	Displays the call-to party (call type) on the standby screen.  Call-to party (call type) ①If "Disable" is selected, the call-to party (call type) that is preset by your dealer is displayed on the standby screen.	Disable, Transmit, Transmit and Receive or All Operations	Disable
Bluetooth	Sets the Bluetooth function.	Disable or Enable	Disable
Bluetooth Auto Connect	Automatically connects a Bluetooth device.	Enable or Disable	Enable
Bluetooth Synchronous Volume	Sets the audio volume setting type for a Bluetooth headset. ①When "Enable" is selected, the Bluetooth headset volume can be set by [PWR/VOL].	Disable or Enable	Disable
Bluetooth Echo Canceller	Sets the Echo Cancelling function for a Bluetooth headset.	Disable or Enable	Enable
Bluetooth Echo canceller Input Gain	Sets the Echo Canceller input gain for a Bluetooth headset.	-40 dB ~ +40 dB	0 dB
Bluetooth Echo canceller Voice Delay	Sets the Echo Canceller delay for a Bluetooth headset.	0milliseconds ~ 160milliseconds	70milliseconds
Bluetooth Noise Canceller	Setst the Noise Cancelling function for a Bluetooth headset.	Disable or Enable	Enable
Bluetooth Power Save	Sets the Power Save function for a Bluetooth headset. ①When "Enable" is selected, the Power Save function automatically activates after 2 minutes of no communication. <ul style="list-style-type: none"> • When a call is received, this function is cancelled. • This function is cancelled when pushing [PTT]. Push [PTT] again to talk. 	Enable or Disable	Disable

4 SET MODE

■ Setting item list (continued)

The shaded items (■) are also displayed in the Basic Set mode.

① Items or default values may differ according to a presetting. Ask your dealer for details.

Item	Description	Option/range	Default
Bluetooth One Touch PTT	Toggles receiving and transmitting by momentarily pushing [PTT] on a Bluetooth headset. Push [PTT] to talk, and push again to return to receive. ① When "Enable" is selected, you do not have to hold down [PTT] while you are talking.	Enable or Disable	Disable
Bluetooth PTT Beep	Sounds a beep when the [PTT] switch on the Bluetooth headset is pushed.	Enable or Disable	Disable
Search Bluetooth Device	Searches for Bluetooth devices.	Search	—
Delete Bluetooth Device	Deletes paired devices.	—	—
Initialize Bluetooth Unit	Initializes the pairing list.	NO or YES	NO
Bluetooth Unit Version	Displays the version number of the internal Bluetooth unit.	—	—
Recording	Sets the Recording function.	Enable or Disable	Disable
Recording Call type	Sets the Call type to be recorded.	Individual Call or All	Individual Call
Delete Recorded Audio	Deletes the recorded audio.	---- or CLR	----
LTE Unit Version	Displays the version number of internal LTE unit.	—	—
IMEI	Displays the IMEI number of the communication unit.	—	—
Phone Number	Displays the SIM card's telephone number.	—	—
ICCID	Displays the SIM card's ICCID.	—	—

① Since obtaining the LTE unit version and ICCID takes time, "Not acquired" may be displayed right after entering the Set mode. However they will be obtained after a while.

① "Not acquired" may be displayed in the Phone Number item, depending on the SIM card.

■ Optional products	5-2
■ Standard charging time and battery life.....	5-3
■ Battery pack cautions	5-4
■ Charging with the optional BC-202IP2	5-6
■ Charging with the optional BC-211.....	5-6
■ Charging with the optional BC-218.....	5-7
■ Insert the IP501H into the BC-218	5-7
■ Bluetooth® operation.....	5-8
■ HM-215/BC-218 description	5-10
■ Charging VS-3.....	5-11
■ Pairing the IP501H with the BC-218 or VS-3	5-12
■ Connecting and disconnecting	5-15
■ Deleting a Bluetooth device from the pairing list	5-21
■ Initializing the pairing list of the IP501H	5-22
■ Initializing the pairing list of the BC-218	5-23
■ Initializing the pairing list of the VS-3	5-24
■ Installing the MBA-7/MBF-1 on a flat surface.....	5-25
■ LC-185 (For BP-272).....	5-28
■ When connecting optional equipment	5-29

5 OPTIONAL PRODUCTS

■ Optional products

Carrying case

LC-185 (For use with BP-272)

Battery Pack

BP-272: Li-ion Battery Pack (Same as supplied)
(Minimum: 1880 mAh, Typical: 2000 mAh)

Chargers

BC-202IP2: Rapid Charger (with BC-123S)
BC-211: Multi-charger (with BC-157S)
BC-218: Rapid Charger (with Bluetooth® function)
BC-123S: AC Adapter (for BC-202IP2)
BC-157S: AC Adapter (for BC-211)
BC-207S: AC Adapter (for BC-218)
CP-22 (For BC-202IP2, BC-218, 12V/24V)
CP-23L (For BC-202IP2 and BC-218, 12V)

Holder

MB-135: Belt Clip (Same as supplied)

Cables

OPC-2006LS: Plug Adapter Cable
OPC-2328: PTT Switch Cable
OPC-2359: PTT Switch Cable
OPC-478UC*³: Programming Cable
OPC-2144: Plug Adapter Cable

Speaker-Microphones

HM-153LS: Earphone Microphone
HM-166LS: Earphone Microphone
HM-183LS: Speaker Microphone
HM-186LS: Speaker Microphone
HM-215: Speaker Microphone (For BC-218)

Headsets

HS-94*¹: Headset (Ear hook type)
HS-95*¹: Headset (Neck and arm type)
HS-97*¹: Throat Microphone
HS-102*²: Headset (Earphone type)
VS-3: Bluetooth® Headset

Mount

MBF-1: Mounting Base (For MBA-7)
MBA-7: Bracket Adapter (For BC-218)

*¹ To use the VOX function, the OPC-2006LS (Plug Adapter Cable) is necessary.

To use the talk switch, the OPC-2328 (PTT Switch Cable) is necessary.

*² The OPC-2359 (PTT Switch Cable) is necessary.

*³ The OPC-2144 (Plug Adapter Cable) is necessary.

5 OPTIONAL PRODUCTS

■ Standard charging time and battery life

NOTE: Operating time may be shorter, depending on the operating condition such as the roaming frequency. Frequently roaming makes the operating time shorter.

① The supplied battery pack is the BP-272.

- Immediately stop using the battery pack if it emits an abnormal odor, heats up, or is discolored or deformed. If any of these conditions occur, contact your Icom dealer or distributor.

Battery	BP-272
Spec item	
Operating time	17 hours (approximately)
	TX:RX:Stand-by=5 : 5 : 90 (seconds)
Charging time	3.5 hours (approximately)
	Charging with the BC-202IP2

5 OPTIONAL PRODUCTS

■ Battery pack cautions

WORD	DEFINITION
⚠ DANGER!	Personal death, serious injury or an explosion may occur.
⚠ WARNING!	Personal injury, fire hazard or electric shock may occur.
CAUTION	Equipment damage may occur.
NOTE	If disregarded, inconvenience only. No risk of personal injury, fire or electric shock.

⚠ **DANGER! NEVER** short the terminals of the battery pack. Shorting may occur if the terminals touch metal objects such as a key, so be careful when placing the battery packs (or the transceiver) in bags, and so on. Carry them so that shorting cannot occur with metal objects. Shorting may damage not only the battery pack, but also the transceiver.

⚠ **DANGER! NEVER** operate the transceiver near unshielded electrical blasting caps or in an explosive atmosphere. This could cause an explosion and death.

⚠ **DANGER! NEVER** use or charge Icom battery packs with non-Icom transceivers or non-Icom chargers. Only Icom battery packs are tested and approved for use with Icom transceivers or charged with Icom chargers. Using thirdparty or counterfeit battery packs or chargers may cause smoke, fire, or cause the battery to burst.

⚠ **WARNING RF EXPOSURE!** This device emits Radio Frequency (RF) energy. Caution should be observed when operating this device. If you have any questions regarding RF exposure and safety standards, please refer to the Federal Communications Commission Office of Engineering and Technology's report on Evaluating Compliance with FCC Guidelines for Human Radio Frequency Electromagnetic Fields (OET Bulletin 65).

⚠ **WARNING! NEVER** hold the transceiver so that the antenna is very close to, or touching exposed parts of the body, especially the face or eyes, while transmitting. The transceiver will perform best if the microphone is 5 to 10 cm (2 to 4 inches) away from the lips and the transceiver is vertical.

⚠ **WARNING! NEVER** operate the transceiver with a headset or other audio accessories at high volume levels. The continuous high volume operation may cause a ringing in your ears. If you experience a ringing, reduce the volume level or discontinue use.

⚠ **WARNING! NEVER** operate the transceiver while driving a vehicle. Safe driving requires your full attention— anything less could result in an accident.

CAUTION: DO NOT use harsh solvents such as Benzine or alcohol when cleaning, because they will damage the transceiver's surfaces.

CAUTION: DO NOT operate the transceiver unless the flexible antenna, battery pack, and jack cover are securely attached. Confirm that the antenna and battery pack are dry before attaching. Exposing the inside of the transceiver to dust or water will result in serious damage to the transceiver. After exposure to water, clean the battery contacts thoroughly with fresh water and dry them completely to remove any water or salt residue.

DO NOT use or place the transceiver in direct sunlight or in areas with temperatures below -10°C (14°F) or above $+60^{\circ}\text{C}$ (140°F).

DO NOT push [PTT] when you do not actually intend to transmit.

DO NOT modify the transceiver. The specifications may change and then the transceiver may not comply with the requirements of required regulations. The transceiver warranty does not cover any problems caused by unauthorized modification.

BE CAREFUL! The transceiver will become hot when operating it continuously for long periods of time.

BE CAREFUL! The transceiver meets IP67* requirements for waterproof protection. However, once the transceiver has been dropped, waterproof protection cannot be guaranteed because of possible damage to the transceiver's case or waterproof seal.

*Only when the BP-272, flexible antenna or antenna cap and SP/MIC jack cap are attached.

The optional BP-272 meets IP67 requirements.

• Battery caution

Misuse of Li-ion batteries may result in the following hazards: smoke, fire, or the battery may rupture. Misuse can also cause damage to the battery or degradation of battery performance.

⚠ **DANGER! NEVER** strike or otherwise impact the battery. Do not use the battery if it has been severely impacted or dropped, or if the battery has been subjected to heavy pressure. Battery damage may not be visible on the outside of the case. Even if the surface of the battery does not show cracks or any other damage, the cells inside the battery may rupture or catch fire.

⚠ **DANGER! NEVER** leave battery pack in places with temperatures above 60°C (140°F). High temperature buildup in the battery, such as could occur near fires or stoves, inside a sun heated car, or in direct sunlight may cause the battery to rupture or catch fire. Excessive temperatures may also degrade battery performance or shorten battery life.

⚠ **DANGER! NEVER** expose the battery to rain, snow, seawater, or any other liquids. Do not charge or use a wet battery. If the battery gets wet, be sure to wipe it dry before using.

⚠ **DANGER! NEVER** incinerate a used battery pack since internal battery gas may cause it to rupture, or may cause an explosion.

⚠ **DANGER! NEVER** solder the battery terminals, or **NEVER** modify the battery pack. This may cause heat generation, and the battery may burst, emit smoke or catch fire.

⚠ **DANGER!** Use the battery only with the transceiver for which it is specified. Never use a battery with any other equipment, or for any purpose that is not specified in this instruction manual.

⚠ **DANGER!** If fluid from inside the battery gets in your eyes, blindness can result. Rinse your eyes with clean water, without rubbing them, and go to a doctor immediately.

⚠ **WARNING!** Immediately stop using the battery if it emits an abnormal odor, heats up, or is discolored or deformed. If any of these conditions occur, contact your Icom dealer or distributor.

⚠ **WARNING!** Immediately wash, using clean water, any part of the body that comes into contact with fluid from inside the battery.

⚠ **WARNING! NEVER** put the battery in a microwave oven, high-pressure container, or in an induction heating cooker. This could cause a fire, overheating, or cause the battery to rupture.

CAUTION: Always use the battery within the specified temperature range, -10°C ~ $+60^{\circ}\text{C}$ (14°F ~ 140°F). Using the battery out of its specified temperature range will reduce the battery's performance and battery life.

CAUTION: Shorter battery life could occur if the battery is left fully charged, completely discharged, or in an excessive temperature environment (above 50°C (122°F)) for an

5 OPTIONAL PRODUCTS

■ Battery pack cautions (continued)

extended period of time. If the battery must be left unused for a long time, it must be detached from the transceiver after discharging. You may use the battery until the battery indicator shows half capacity, then keep it safely in a cool and dry place at the following temperature range:

- 20°C (-4°F) ~ +50°C (+122°F) (within a month)
- 20°C (-4°F) ~ +35°C (+95°F) (within three months)
- 20°C (-4°F) ~ +20°C (+68°F) (within a year)

BE SURE to replace the battery pack with a new one approximately five years after manufacturing, even if it still holds a charge. The inside battery material will become weak after a period of time, even with little use. The estimated number of times you can charge the battery is between 300 and 500. Even when the battery appears to be fully charged, the operating time of the transceiver may become short when:

- Approximately five years have passed since the battery was manufactured.
- The battery has been repeatedly charged.

• Charging caution

⚠ **DANGER! NEVER** charge the battery pack in areas with extremely high temperatures, such as near fires or stoves, inside a sun-heated vehicle, or in direct sunlight. In such environments, the safety/protection circuit in the battery will activate, causing the battery to stop charging.

⚠ **WARNING! NEVER** charge the transceiver during a lightning storm. It may result in an electric shock, cause a fire or damage the transceiver. Always disconnect the power adapter before a storm.

⚠ **WARNING! NEVER** insert the transceiver (battery attached to the transceiver) into the charger if it is wet or soiled. This could corrode the battery charger terminals or damage the charger. The charger is not waterproof.

⚠ **WARNING! DO NOT** charge or leave the battery in the battery charger beyond the specified time for charging. If the battery is not completely charged by the specified time, stop charging and remove the battery from the battery charger. Continuing to charge the battery beyond the specified time limit may cause a fire, overheating, or the battery may rupture.

CAUTION: NEVER charge the battery outside of the specified temperature range:

- BC-202IP2: 10°C ~ 40°C (50°F ~ 104°F)
- BC-211: 10°C ~ 40°C (50°F ~ 104°F)
- BC-218: 10°C ~ 40°C (50°F ~ 104°F)

Icom recommends charging the battery at 25°C (77°F). The battery may heat up or rupture if charged out of the specified temperature range. Additionally, battery performance or battery life may be reduced.

5 OPTIONAL PRODUCTS

■ Charging with the optional BC-202IP2

Fully charge the battery pack when the first time of use or has not been used for more than 2 months.

WARNING! NEVER charge the transceiver during a lightning storm. It may result in an electric shock, cause a fire or damage the transceiver. Always disconnect the power adapter before a storm.

- Turn OFF the transceiver power before charging. Otherwise, the battery may not be fully charged.
- Insert the transceiver (battery attached to the transceiver) into the charger as shown to the right.
- Charging indicator lights orange while charging. When the battery pack is fully charged, lights green. If the indicator Blinks orange, read the IP501H instruction manual on the Icom web site.
- The charger automatically restarts charging when the attached battery pack voltage drops.
- Disconnect the AC cable from the outlet when the charger is not in use.

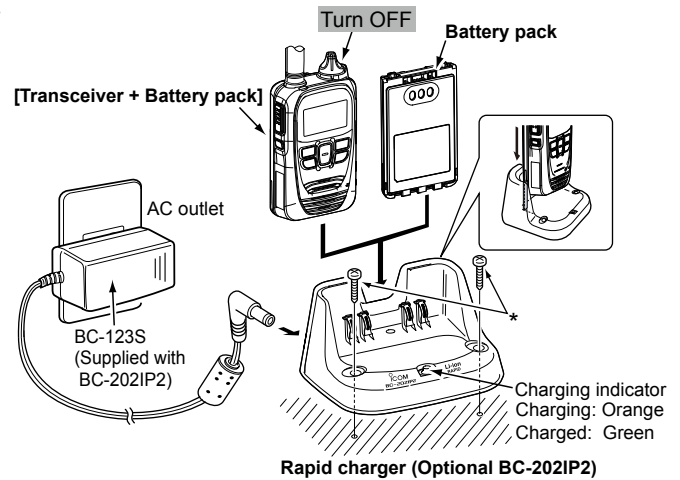

⚠ DANGER

- Use and charge only specified Icom battery packs with Icom transceivers or Icom chargers. Only Icom battery packs are tested and approved for use with Icom transceivers or charged with Icom chargers. Using third party or counterfeit battery packs or chargers may cause smoke, fire, or cause the battery to burst.
- Use the battery only with the transceiver for which it is specified. Never use a battery with any other equipment, or for any purpose that is not specified in this instruction manual.
- Read the "PRECAUTION" leaflet that is supplied with the IP501H, before attempt to charging the battery pack.

■ Charging with the optional BC-211

The BC-211 rapidly charges up to 6 battery packs.
Charging time: Approximately 3.5 hours (BP-272)
The following item is required.

- A power adapter (not supplied with some versions.)

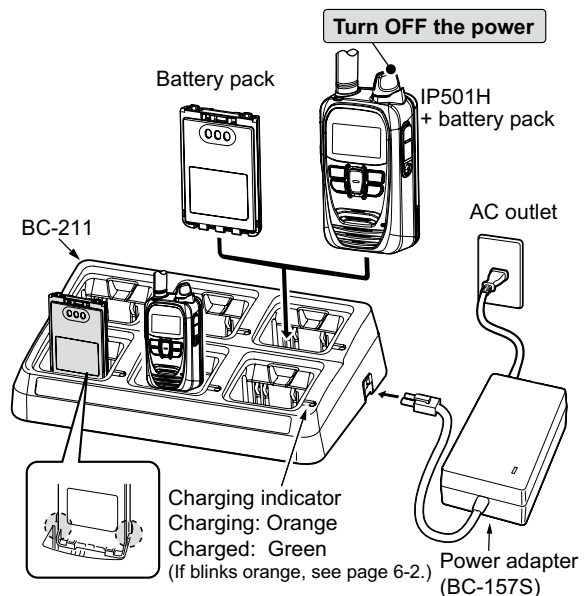

5 OPTIONAL PRODUCTS

■ Charging with the optional BC-218

The BC-218 is designed to rapidly charge the BP-272 Li-ion battery pack.

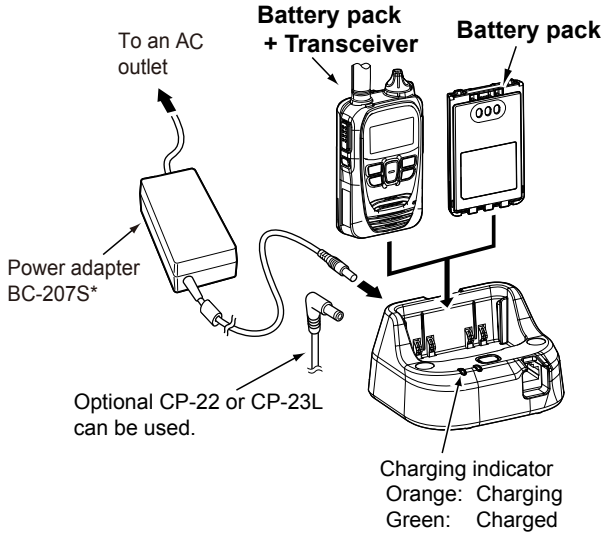

Approximate charging time

BP-272: 2.1 hours (when charging the battery pack only)

① Charging time may differ, depending on the using conditions of the transceiver while charging.

NOTE:

- The rapid charger, BC-218 has a charging timer that stops charging after approximately 5 hours has passed.
- If the battery pack does not properly charge when it is attached to the transceiver, remove it from the transceiver and insert only the battery pack into the charger.
- After charging is completed, the BC-218 will automatically recharge a battery pack when the battery voltage decreases. When the battery pack is often left in the BC-218 for long periods of time, the battery life cycle will be shortened.

* May not be supplied, or the shape may differ, depending on the charger version.

■ Insert the IP501H into the BC-218

You can insert and charge a transceiver that has the belt clip attached. Attach the belt clip, then insert the IP501H into the BC-218 until it is locked in place.

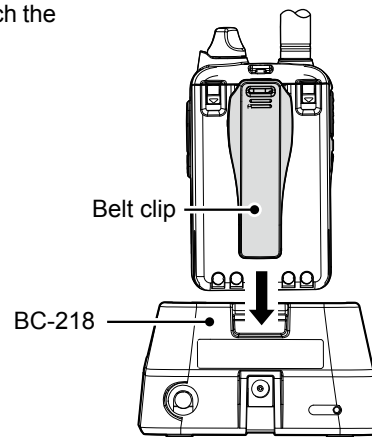

5 OPTIONAL PRODUCTS

■ Bluetooth® operation

- You can connect to other Bluetooth wireless technology enabled devices (Headset or Charger) with the installed Bluetooth unit.
 - ① Only the BC-218 and VS-3 are guaranteed as of December 2017.
 - ① This function may not be usable, depending on a preset. Ask your dealer for detail.
- The communication range of Bluetooth is approximately 10 meters (33 feet).
- Up to 6 Bluetooth devices can be stored on the pairing device list. But using only 2 Bluetooth devices is recommended.

About the Electromagnetic Interference:

Bluetooth uses the 2.4 GHz band. When using the BC-218 in the 2.4 GHz band near a Bluetooth device, interference may occur. This may cause a decrease in communication speed, or an unstable connection. In such a case, use the BC-218 away from the Bluetooth device communication area, or stop using the Bluetooth device.

◎ BC-218 Rapid Charger

When you connect the optional HM-215 SPEAKER MICROPHONE to the BC-218, you can transmit and receive the audio by wirelessly connecting to the IP501H and BC-218.

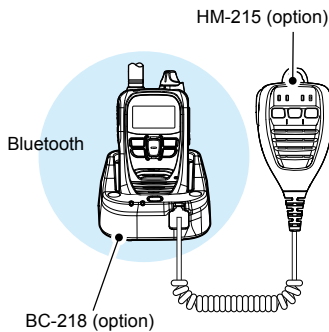

◎ VS-3 Bluetooth® Headset

When you connect the optional VS-3* Bluetooth HEADSET to the transceiver, you can wirelessly transmit and receive the headset audio. The VS-3 has a [PTT] switch, so you can transmit in the same way as using the transceiver's [PTT] switch.

- ① [FWD], [RWD] and [PLAY] keys on the VS-3 are disabled.

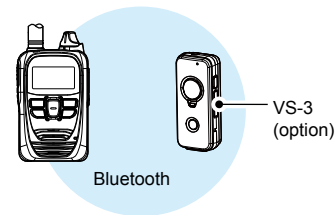

NOTE:

The audio volume control differs, depending on the "Bluetooth Synchronous Volume" item setting (p. 4-6) and Bluetooth function.

Volume linkage	IP501H volume setting	
	BC-218	VS-3
Disable	10*	32
Enable	According to IP501H's the [PWR/VOL] dial'	

*While using the HM-215, the volume level can be adjusted by the [VOL] (+) and [VOL] (-) keys.

5 OPTIONAL PRODUCTS

■ Bluetooth® operation (continued)

Read the instructions following the procedures shown below.

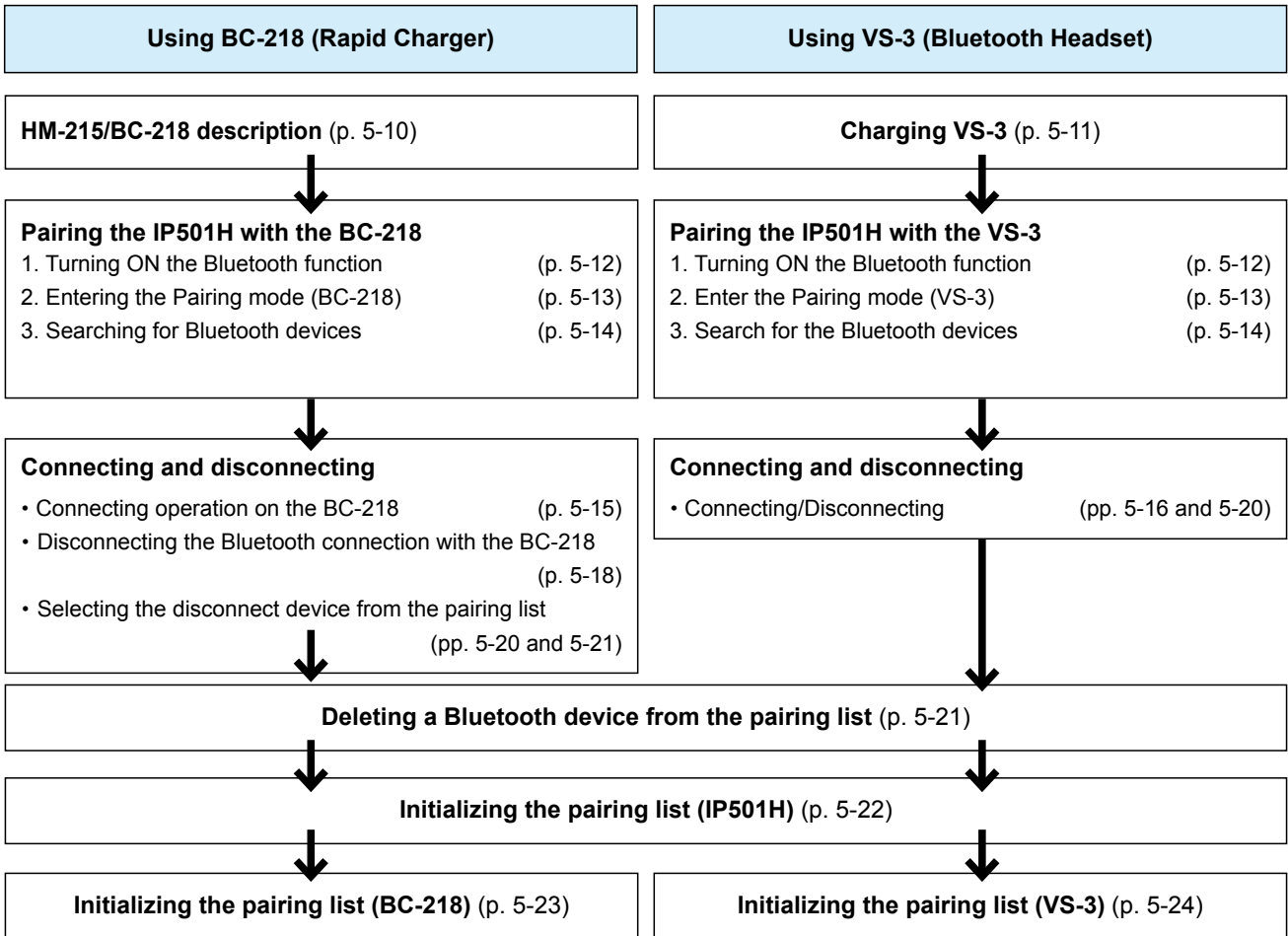

TIP:

You can configure the Bluetooth function In the Set mode.

5 OPTIONAL PRODUCTS

■ HM-215/BC-218 description

Insert the HM-215 into the BC-218's MIC jack, and place the BC-218 on a flat surface.

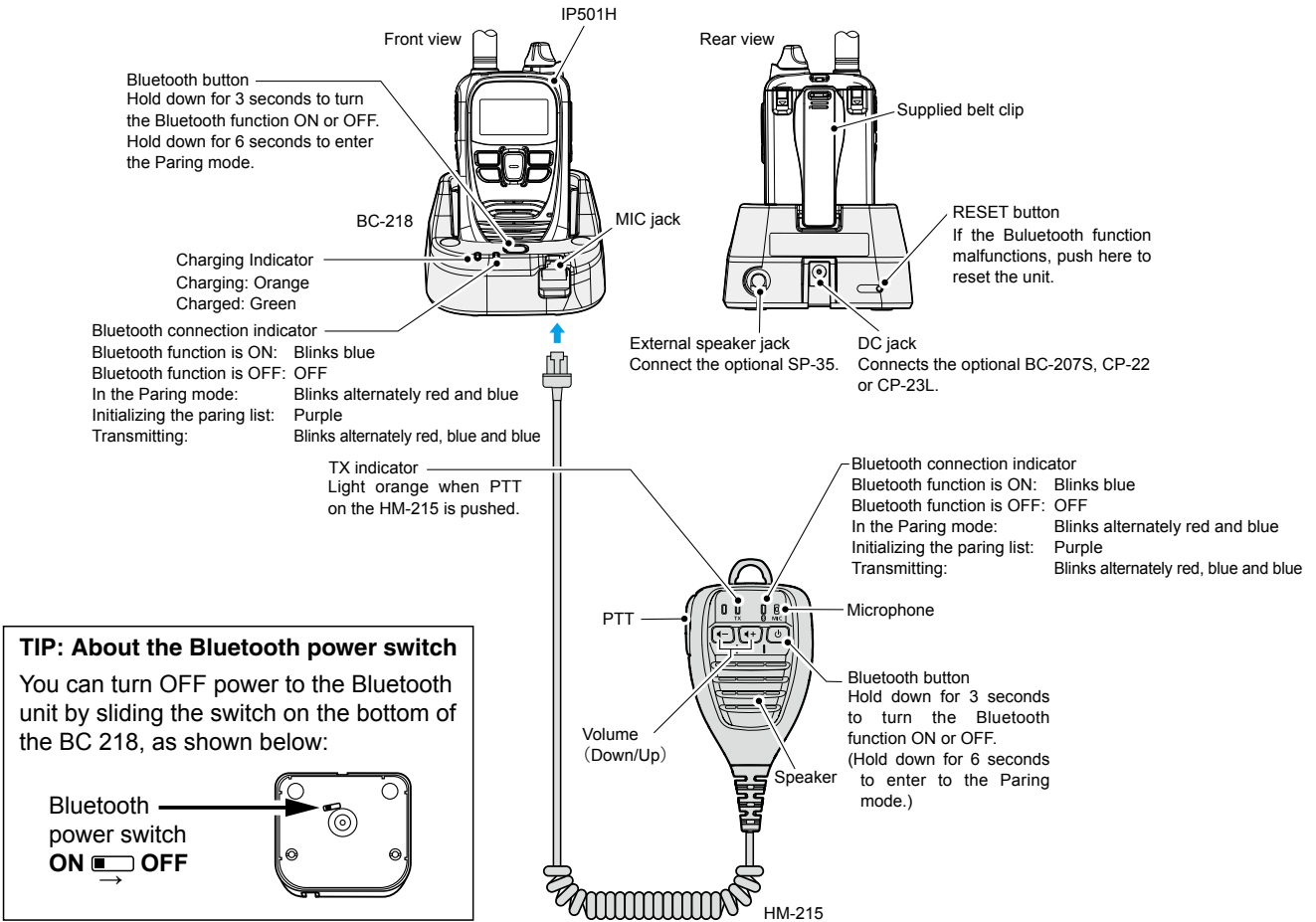

Function	Operation	Confirmation beep	Bluetooth indicator
Turning ON the Bluetooth function	Hold down the [Bluetooth] button for 3 seconds.	Melody sounds (Scale goes up)	Blinks blue
Turning OFF the Bluetooth function	Hold down the [Bluetooth] button for 3 seconds.	Melody sounds (Scale goes down.)	OFF
Pairing	When the Bluetooth function is OFF, hold down the [Bluetooth] button for 6 seconds	Ready to connect: "PiPa."	Alternately Blinks red and blue while waiting for a connection
		Connected: "PiRo"	Blinks blue twice every 3 seconds when connected
Making a call*1	Push [PTT].	"Pi"*2 (Default)	Blinks red once then Blinks blue twice every 3 seconds
Setting the volume up*1	Push [+]	—	—
Setting the volume down*1	Push [-]	—	—

① If the Bluetooth function is ON and the pairing list is blank, the BC-218 starts up in the Pairing mode.

*1 Functional only when a Bluetooth device is connected.

*2 The melody differs, depending on the "Calling Notice Tone" item (p. 4-4) or "Bluetooth PTT Beep" item (p. 4-7) in the Set mode.

5 OPTIONAL PRODUCTS

■ Charging VS-3

Fully charge the VS-3 before using. Charging is also necessary when the LED blinks red every 3 seconds.

1. Make sure the headset power is OFF.
 - If it's ON, hold down [PWR] for 3 seconds.
2. Open the USB port cover, and then connect the VS-3 to a USB power adapter, or a PC, with the supplied USB cable.
 - While charging, the LED lights red.
 - When the charge is completed, the LED turns OFF.

⚠ DANGER!

The charging time is approximately 3 hours. If the LED does not turn OFF after 3 hours of charging, disconnect the USB cable to stop charging. Overcharge may degrade the battery performance or shorten battery life. Also, it may cause a fire or explosion. While charging, you cannot use the headset.

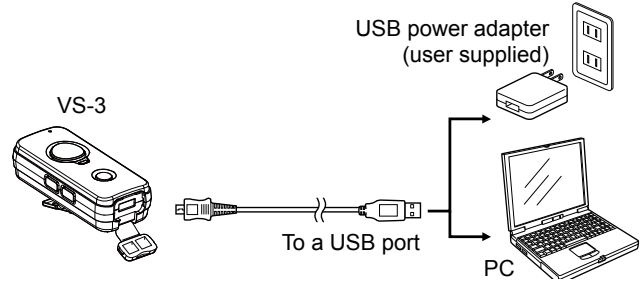

NOTE:

- If the headset does not operate normally, try the following to perform a force power OFF.
- When the volume is set to too low in level, the audio may not be loud enough to hear. Setting the volume level to “28” or higher is recommended.

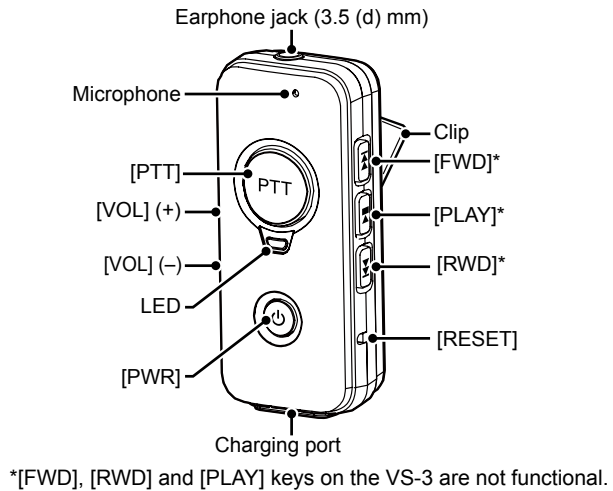

Function	Operation	Confirmation beep	Bluetooth indicator
Turning ON the Bluetooth function	Hold down the [Bluetooth] button for 3 seconds.	Melody sounds (Scale goes up)	Blinks blue
Turning OFF the Bluetooth function	Hold down the [Bluetooth] button for 3 seconds.	Melody sounds (Scale goes down.)	OFF
Pairing	When the Bluetooth function is OFF, hold down the [Bluetooth] button for 6 seconds	Ready to connect: "PiPa-"	Alternatively Blinks red and blue while waiting for a connection.
		Connected: "PiRo"	Blinks blue twice every 3 seconds when connected.
Making a call*1	Push [PTT].	"Pi"*2 (Default)	Blinks red once then Blinks blue twice every 3 seconds.
Setting the volume up*1	Push [+]	"Pi" (High tone sounds when the volume is set to the maximum level.)	—
Setting the volume down*1	Push [-]	"Boo" (Low tone sounds when the volume is set to the minimum level.)	—

① If the Bluetooth function is ON and the pairing list is blank, the VS-3 starts up in the Pairing mode.

*1 Functional only when a Bluetooth device is connected.

*2 The melody differs, depending on the “Calling Notice Tone” item (p. 4-4) or “Bluetooth PTT Beep” item (p. 4-7) in the Set mode.

5 OPTIONAL PRODUCTS

■ Pairing the IP501H with the BC-218 or VS-3

Pairing is a process to be able to establish a connection between a headset and other Bluetooth devices. Once pairing is established with the device, there is no need to pair again.

- You may not find a target Bluetooth device if there are many other Bluetooth® devices nearby. In that case, stop using those devices, or move away from them.
- When the Bluetooth function is turned OFF, the audio is output from the IP501H. Be sure to not set the IP501H's volume level too high.

① Guaranteed Bluetooth devices are the BC-218 and VS-3. (as of December 2017)

1. Turning ON the Bluetooth function

1. While holding down [FUNC], turn ON the transceiver power.
 - Enters the Set mode.
2. Release [FUNC] when "SET" is displayed.
3. Push [FUNC] several times to select "Bluetooth."
4. Push [▲]/[▼] to select "Enable."
5. Push [CLR/LOCK].
 - Exits the Set mode.

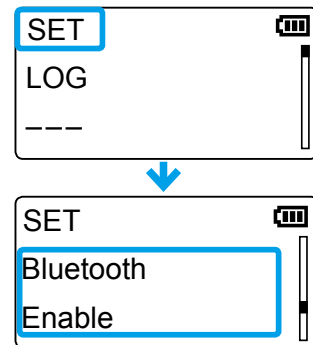
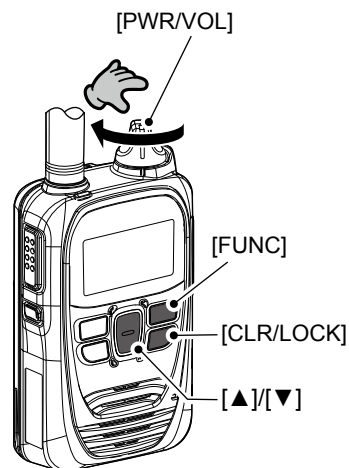

5 OPTIONAL PRODUCTS

■ Pairing the IP501H with the BC-218 or VS-3 (continued)

2. Enter the Pairing mode with the BC-218

1. Connect the optional HM-215 to the BC-218.
2. When the Bluetooth function is OFF, hold down the Bluetooth button of either the BC-218 or HM-215) for approximately 6 seconds until the Bluetooth indicator starts alternately blinking red and blue.
 - A beep sounds.
3. Release the Bluetooth button.
 - ① If the pairing list is blank, the BC-218 automatically enters the Pairing mode when the BC-218 is turned ON.
 - ① If 5 minutes has passed without any device paired, the Pairing mode is automatically canceled. After another 5 minutes has passed, the BC-218's power is automatically turned OFF.

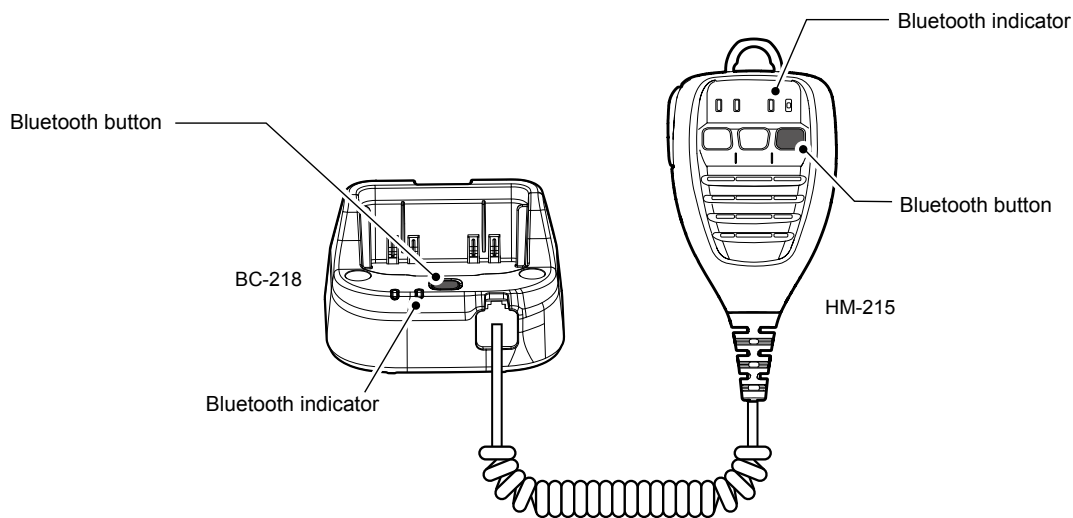

2. Enter the Pairing mode with the VS-3

1. When the Bluetooth function is OFF, hold down the [PWR] button for approximately 6 seconds (until the LED starts alternately blinking red and blue).
 - A beep sounds.
2. Release the Bluetooth button.
 - ① If the pairing list is blank, the VS-3 automatically enters the Pairing mode when the VS-3 is turned ON.
 - ① If 5 minutes has passed without any device paired, the Pairing mode is automatically canceled. After another 5 minutes has passed, the VS-3's power is automatically turned OFF.

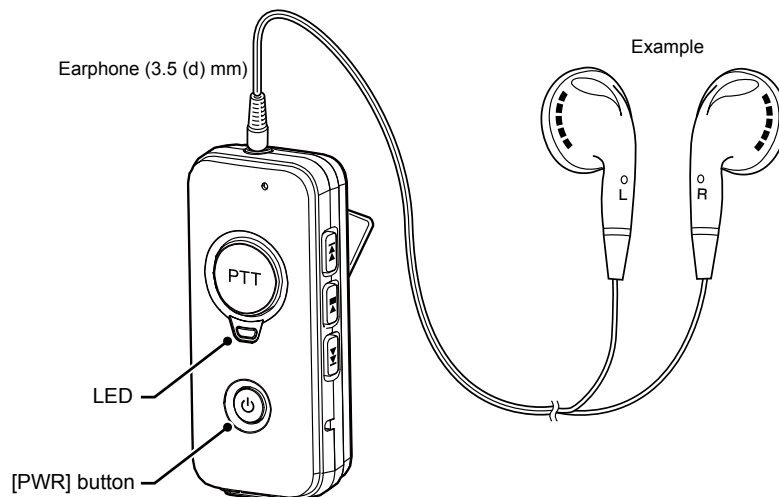

5 OPTIONAL PRODUCTS

■ Pairing the IP501H with the BC-218 or VS-3 (continued)

3. Search for Bluetooth devices

1. While holding down [FUNC], turn ON the power.
 - Enters the Set mode.
2. Release [FUNC] when “SET” is displayed.
3. Push [FUNC] several times to select “Search Bluetooth Device.”
4. Push [Call history].
 - “Searching...” is displayed
 - When Bluetooth devices are found, their device name and BD address are displayed on the screen.
5. Push [▲]/[▼] to select a device, then push to [Call history].
 - When the pairing has succeed, “Connect” is displayed.
 - To retry the search, push [▲]/[▼] to select “Search,” then push [Call history].
6. Push [CLR/LOCK].
 - Exits the Set mode.

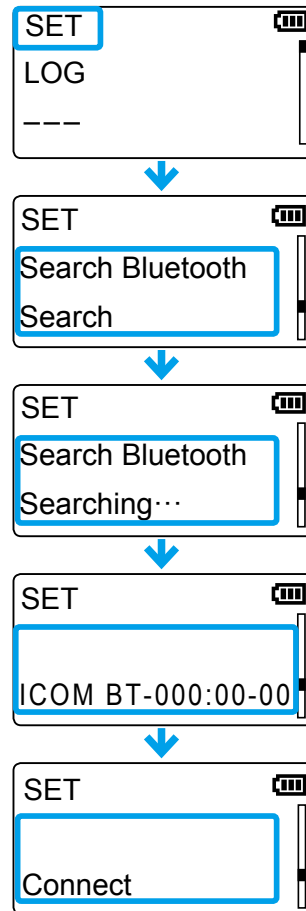
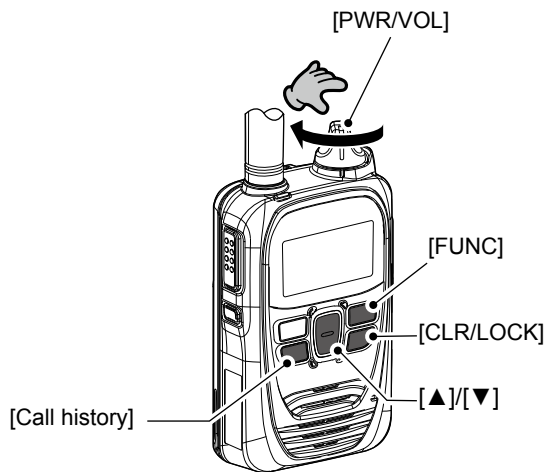

5 OPTIONAL PRODUCTS

■ Connecting and disconnecting

Connecting with the BC-218 when the Bluetooth indicator is OFF

1. Turn ON the IP501H's Bluetooth function. (p. 5-12)
2. Hold down the Bluetooth button on the BC-218 for 3 seconds.
 - The Bluetooth function is ON, and the Bluetooth indicator Blinks blue.
 - After a few seconds, a beep sounds and the Bluetooth connection between the IP501H and the BC-218 is established.

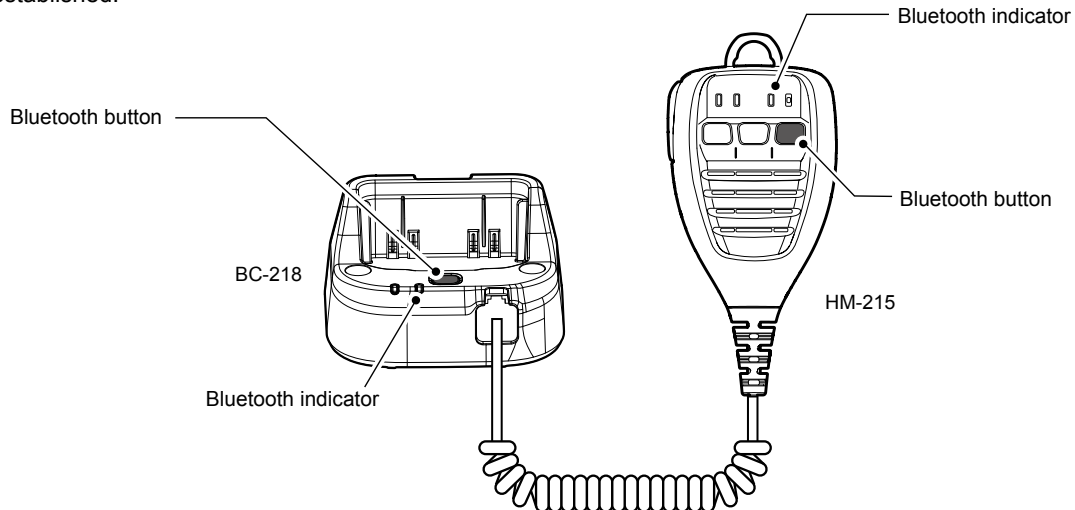

Connecting with the BC-218 when the Bluetooth indicator blinks blue

1. Turn ON the IP501H's Bluetooth function. (p. 5-12)
2. Push [PTT] on the HM-215 that is connected to the BC-218.
 - After few seconds, a beep sounds and the Bluetooth connection between the IP501H and the BC-218 is established.
 - ① The paired device can be identified by its BD address on the "Pairing List." (p. 5-17)

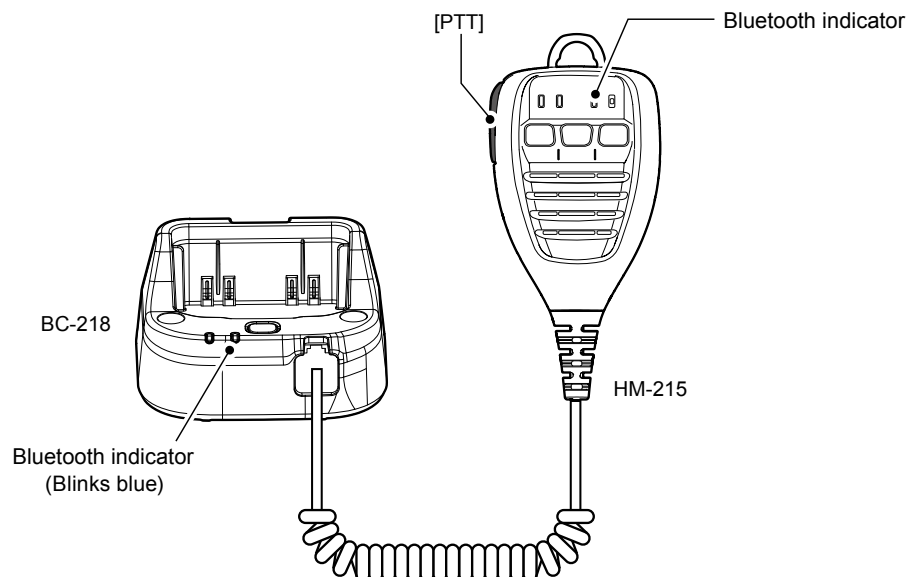

5 OPTIONAL PRODUCTS

■ Connecting and disconnecting (continued)

Connecting with the VS-3 when the Bluetooth indicator is OFF

1. Turn ON the IP501H's Bluetooth function. (p. 5-12)
2. Hold down the [PWR] button on the VS-3 for 3 seconds.
 - The Bluetooth function is ON, and the Bluetooth indicator Blinks blue.
 - After few seconds, a beep sounds and the Bluetooth connection between the IP501H and the VS-3 is established.

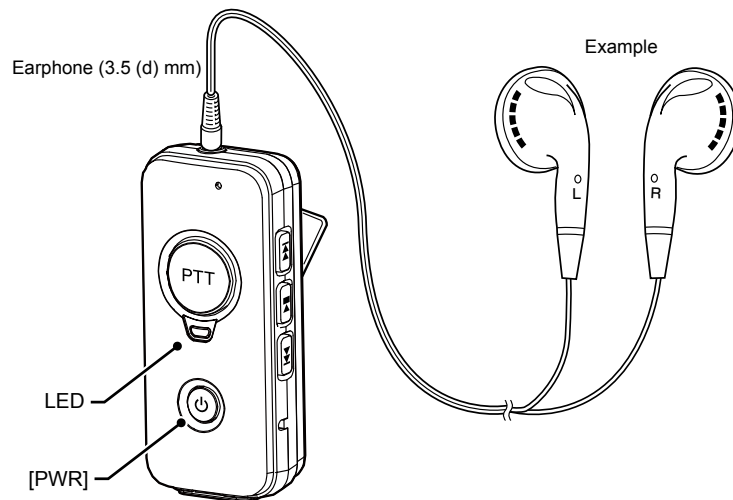

Connecting with the VS-3 when the Bluetooth indicator blinks blue

1. Turn ON the IP501H's Bluetooth function. (p. 5-12)
2. Hold down [PTT] on the VS-3 for 3 seconds.
 - After few seconds, a beep sounds and the Bluetooth connection between the IP501H and the VS-3 is established.
 - ① The paired device can be identified by its BD address on the "Pairing List." (p. 5-17)

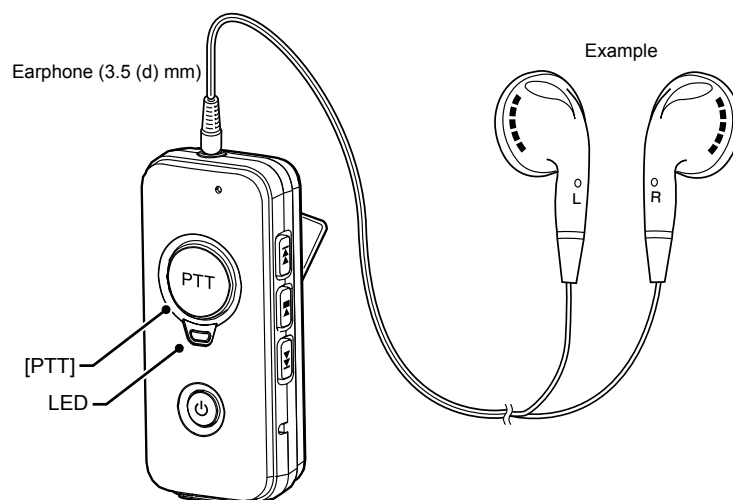



5 OPTIONAL PRODUCTS

■ Connecting and disconnecting (continued)

Selecting the device to connect from the pairing list.

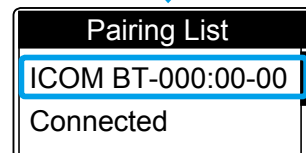
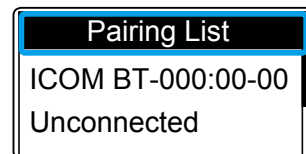
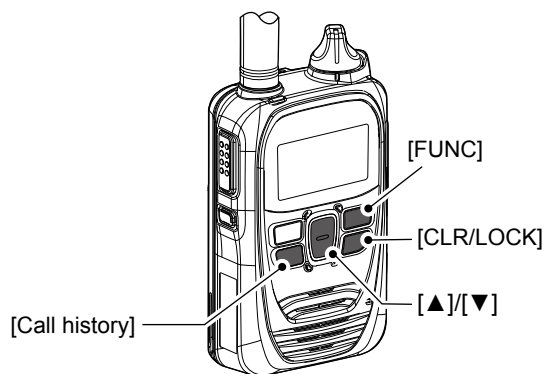
1. Turn ON the Bluetooth function. (p. 5-12)
2. Push [FUNC] to select "Pairing List."
3. Push [▲]/[▼] to select a Bluetooth device to connect.
4. Push [Call history].
 - After few seconds, a beep sounds and the Bluetooth connection between the IP501H and the selected device is established.
5. Push [CLR/LOCK].
 - Exits the Set mode.



The  icon appears

5 OPTIONAL PRODUCTS

■ Connecting and disconnecting (continued)

Disconnecting a Bluetooth device by removing the IP501H from the BC-218

- Remove the IP501H from the BC-218.
 - A beep sounds, and then the Bluetooth device is disconnected.

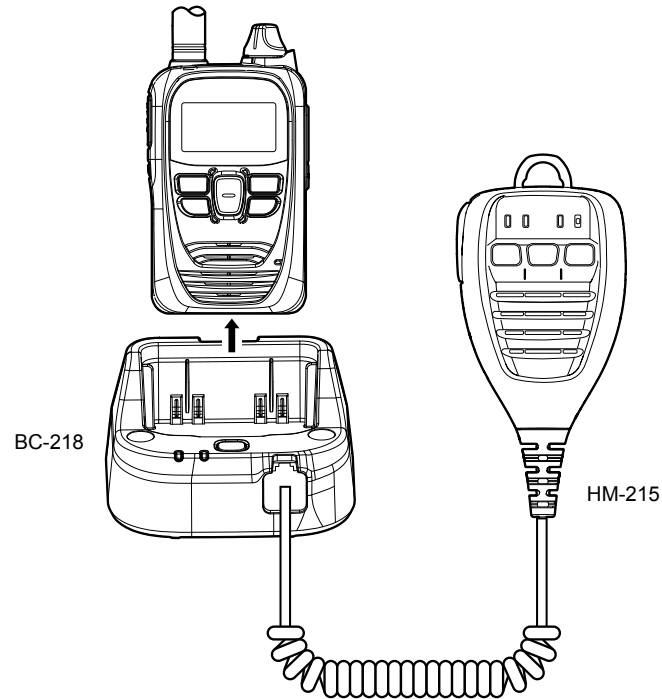

NOTE:

- When you remove the IP501H from the BC-218 then insert the IP501H again within 10 minutes, the Bluetooth connection is automatically established again.
- When 10 minutes has passed after the IP501H is removed from the BC-218, the BC-218's Bluetooth function is automatically turned OFF.

5 OPTIONAL PRODUCTS

■ Connecting and disconnecting (continued)

Disconnecting with the BC-218 when the Bluetooth indicator blinks blue

- Hold down the Bluetooth button on the BC-218 for 3 seconds.
 - Sounds a beep then melody (Scale goes down), and the Bluetooth connection between the IP501H and the BC-218 is disconnected.

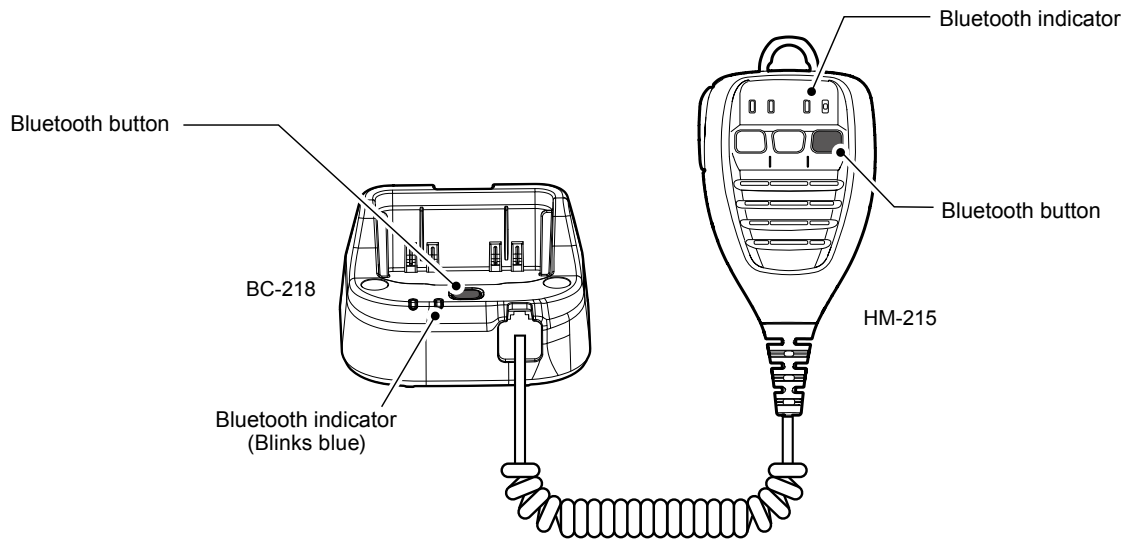

5 OPTIONAL PRODUCTS

■ Connecting and disconnecting (continued)

Disconnecting the VS-3 when the LED blinks blue

- Hold down the [PWR] button on the VS-3 for 3 seconds.
 - Sounds a beep then melody (Scale goes down), and the Bluetooth connection between IP501H and VS-3 are disconnected.

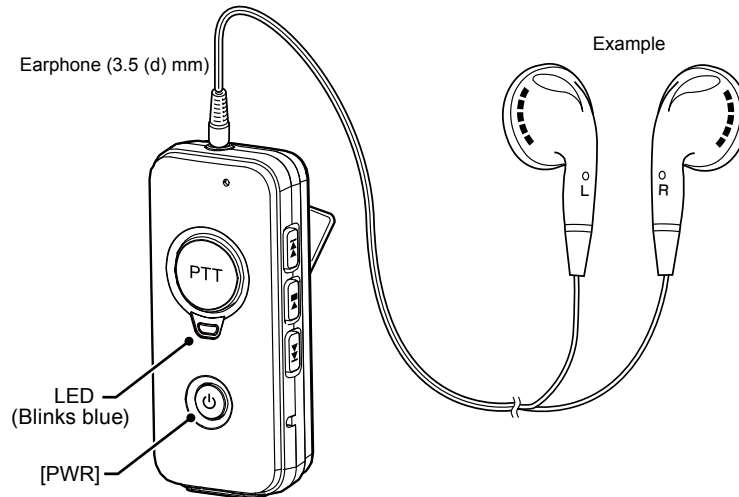

Selecting the device to disconnect from the pairing list.

1. Push [FUNC] to select "Pairing List."
2. Push [▲]/[▼] to select the Bluetooth device to disconnect.
3. Push [Call history].
 - After few seconds, a beep sounds and the Bluetooth connection between IP501H and the selected Bluetooth device is disconnected.
4. Push [CLR/LOCK].
 - Returns to the standby screen.

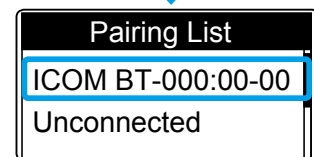
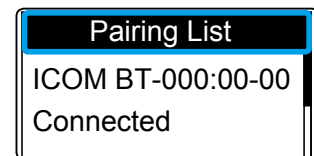

The "BT" icon is no longer displayed

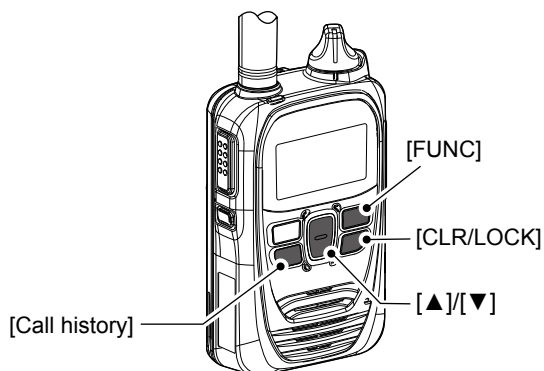

5 OPTIONAL PRODUCTS

■ Deleting a Bluetooth device from the pairing list

You can delete Bluetooth devices from the "Pairing List" screen.

① Disconnect the Bluetooth device before deleting if connected. (pp. 5-17 and 5-18)

1. While hold down [FUNC] and [Address], turn ON the power.
 - Enters the Set mode.
2. Release [FUNC] and [Address] when "SET" is displayed.
3. Push [FUNC] several times to select "Delete Bluetooth Device."
4. Push [▲]/[▼] to select the device to delete.
5. Push [Call history].
 - "Delete?" is displayed.
 - To cancel deleting, push any key other than [Call history].
6. Push [Call history].
 - The selected device is deleted from the pairing list, then exits the Set mode.

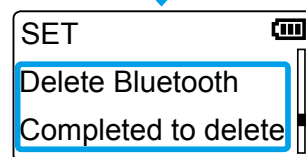
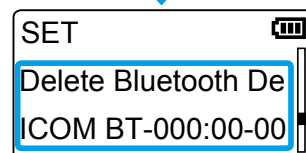
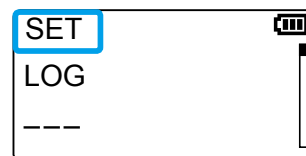
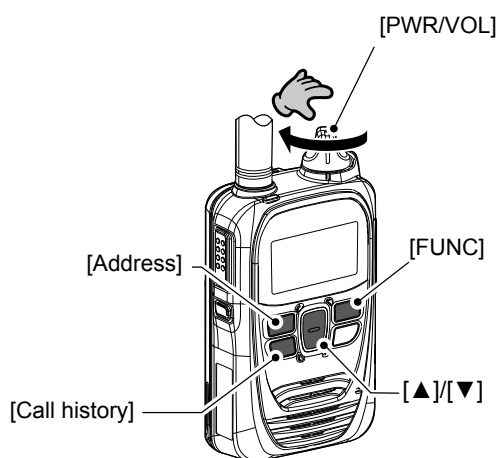

5 OPTIONAL PRODUCTS

■ Initializing the pairing list of the IP501H

If you have some troubles with the Bluetooth operation, initialize the pairing list, as shown below.

- ① All the paired Bluetooth devices are deleted from the pairing list by the initialization.
- ② The pairing list is not initialized by the “RESET” item in the Set mode.

1. While hold down [FUNC] and [Address], turn ON the power.
 - Enters the Set mode.
2. Release [FUNC] and [Address] when “SET” is displayed.
3. Push [FUNC] several times to select “Initialize Bluetooth Unit.”
4. Push [▲]/[▼] to select “YES.”
 - To cancel the initialization, push any key other than [Call history].
5. Push [Call history].
 - The pairing list is initialized and IP501H automatically restarts.

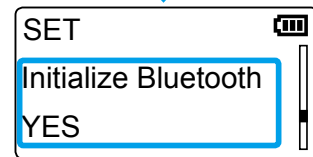
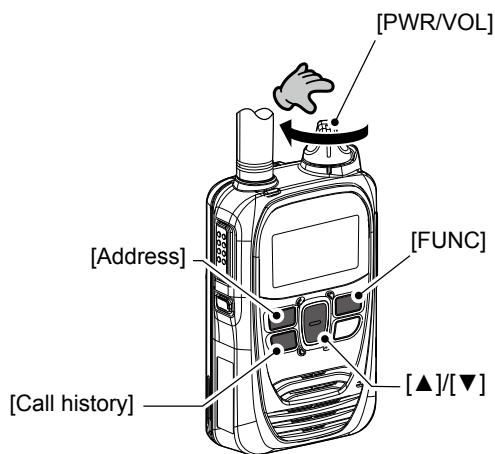

5 OPTIONAL PRODUCTS

■ Initializing the pairing list of the BC-218

If you have some troubles with the Bluetooth operation, initialize the pairing list, as shown below.

1. Connect the HM-215 to the BC-218.
2. Hold down the Bluetooth button on the BC-218 for 3 seconds, to turn ON the Bluetooth function.
 - The Bluetooth indicator Blinks blue.
3. Hold down the Bluetooth button on the BC-218 for 3 seconds again, to turn OFF the Bluetooth function.
 - The Bluetooth indicator turns OFF.
4. Within 10 seconds after holding down both [UP] and [DOWN] on the HM-215, hold down the Bluetooth button for 10 seconds.
 - The Bluetooth indicator lights violet, and the pairing list is initialized.

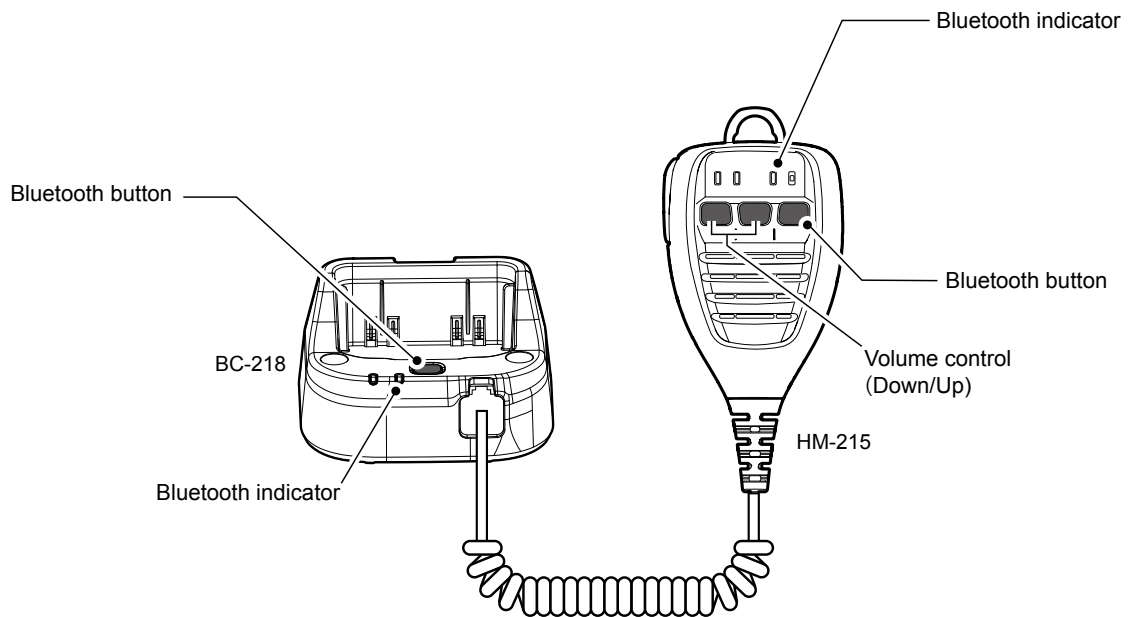

5 OPTIONAL PRODUCTS

■ Initializing the pairing list of the VS-3

If you have some troubles with the Bluetooth operation, initialize the pairing list, as shown below.

1. Hold down [PWR] on the VS-3 for 3 seconds, to turn ON the Bluetooth function.
 - The LED Blinks blue.
2. Hold down [PWR] on the VS-3 for 3 seconds again, to turn OFF the Bluetooth function.
 - The LED turns OFF.
3. Within 10 seconds after holding down both [VOL] (-) and [VOL] (+), hold down [PWR] for 10 seconds.
 - The LED lights violet, and the pairing list is initialized.

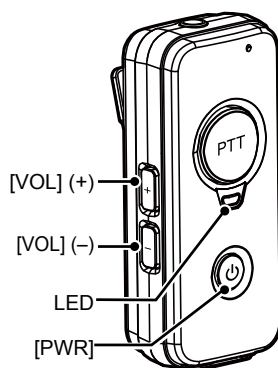

5 OPTIONAL PRODUCTS

■ Installing the MBA-7/MBF-1 on a flat surface

1. Clean the surface where the MBF-1 is attached to.
① To install the MBF-1, approximately 90 mm² of flat surface is necessary.
2. Attach the MBA-7 to the MBF-1.

- ③ Move the holder left or right to the best viewing position, then tighten the lock knob.

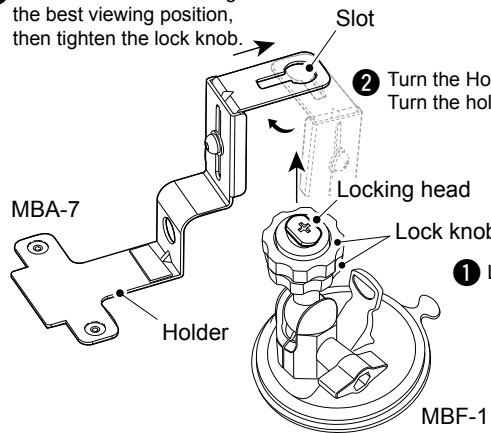

- ② Turn the Holder so the slot can be placed over the locking head. Turn the holder back forward, and slide the slot's guide under the MBF-1's locking head.

- ① Loosen the lock knob

5 OPTIONAL PRODUCTS

■ Installing the MBA-7/MBF-1 (continued)

3. Make sure that the surface where MBF-1 is attached to is clean and dry, then attach the MBF-1.
4. Adjust the angle and position of MBA-7 with the MBF-1's adjusting dial and screw.

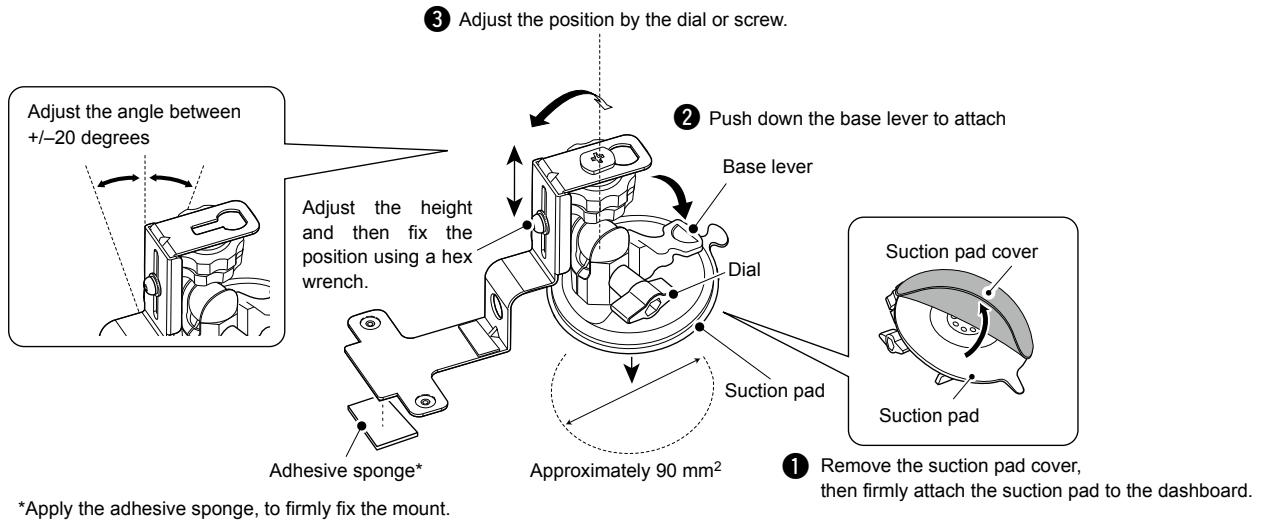

5. Attach the BC-218 to the MBA-7, then connect the DC cable.
6. Attach the strap for the fall prevention.

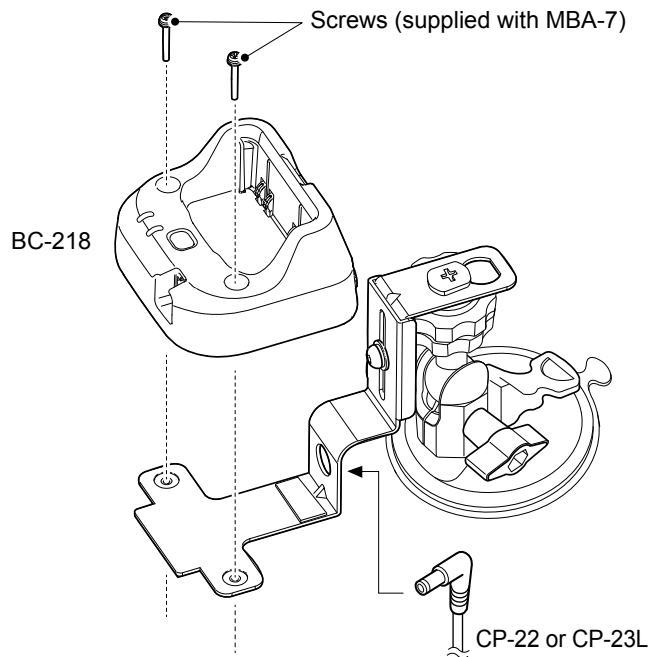

5 OPTIONAL PRODUCTS

■ Installing the MBA-7/MBF-1 (continued)

1 Attach the strap to the hook.

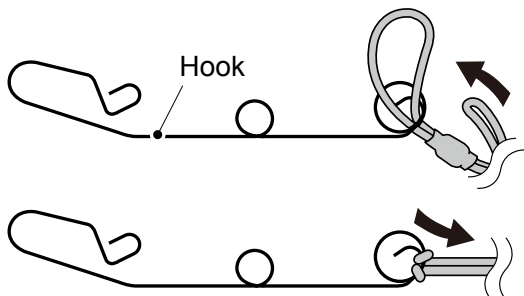

3 Attach the hook to a hole.

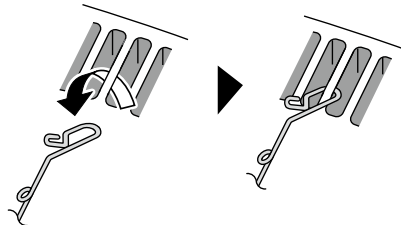

4 Adjust the length.



2 Attach the strap to the MBA-7.

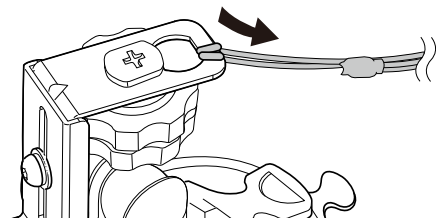
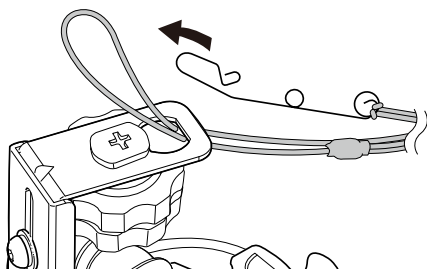

If there is no hook to hang it:
Make a hole and drill a tapping screw.

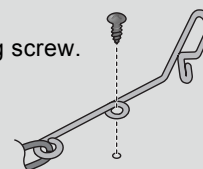

5 OPTIONAL PRODUCTS

■ LC-185 (For BP-272)

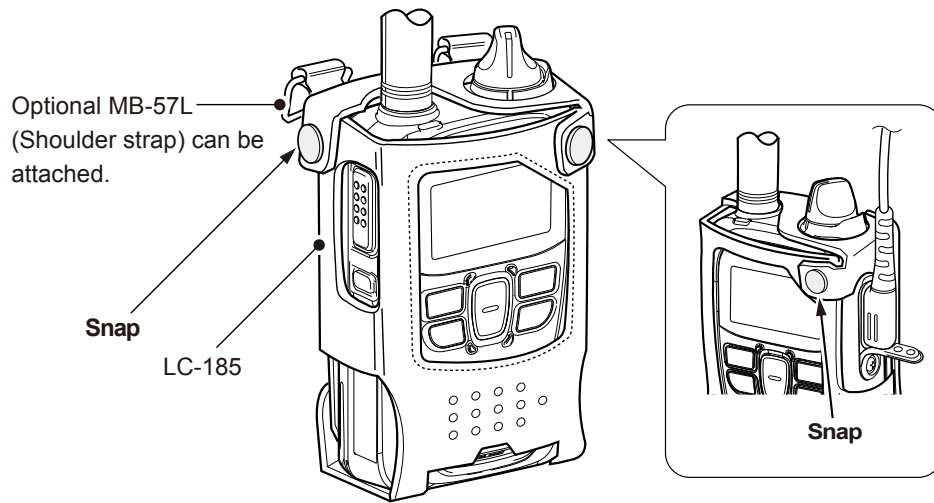

When you charge the BC-272 attached to the IP501H with LC-185, open the bottom part and insert to the BC-218, as shown below.

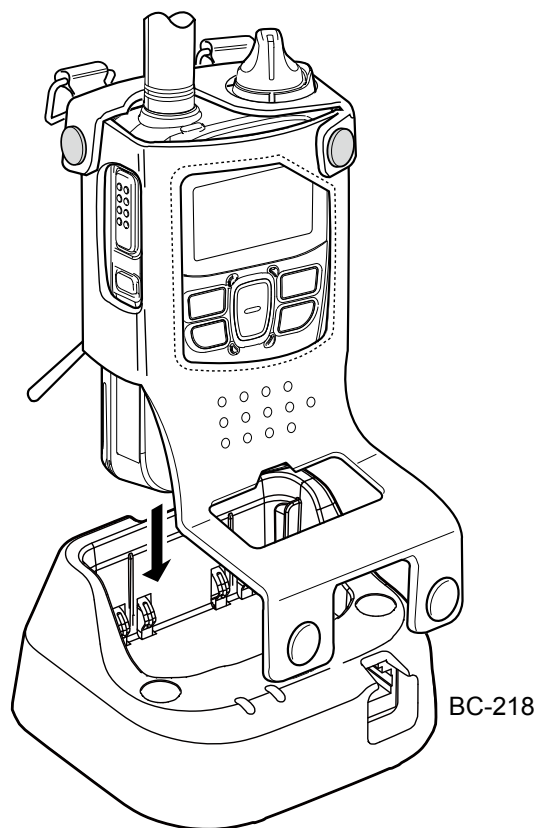

5 OPTIONAL PRODUCTS

■ When connecting optional equipment

- Be sure to turn OFF the power before connecting or disconnecting optional equipment to or from the jack.
 - Remove the cable by holding the plug not cable.
 - Insert the plug securely when connecting the cable.
- ① Attach the jack cover when no optional equipment is connected.

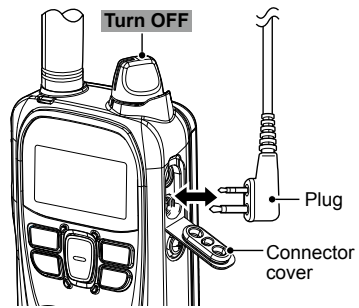

Optional equipment is attached

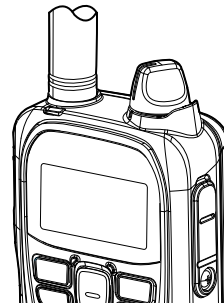

Connector cover is attached

FOR YOUR REFERENCE

Section 6

■ Troubleshooting.....	6-2
■ Specifications	6-4

6 FOR YOUR REFERENCE

■ Troubleshooting

The following chart is designed to help you to correct problems that are not equipment malfunctions. If you are unable to locate the cause of a problem, or solve it through the use of this chart, contact your dealer.

PROBLEM	POSSIBLE CAUSE	SOLUTION	REFERENCE
No power comes ON.	Loose connection of the battery pack.	Clean the battery pack terminals.	–
	The battery is exhausted.	Charge the battery pack.	–
	The battery pack's over-discharge protection circuitry is activated.	Remove the battery pack from the IP501H, then charge it for a while. Attach the battery pack to the IP501H again, then turn ON the power.	–
No sound comes from the speaker nor earphone.	Volume level is set too low.	Rotate [PWR/VOL] to increase the volume level.	p. 1-3
Calls cannot be made	The call-to party number or group number is wrong.	Check the call-to party number or group number.	pp. 2-4, 3-5
No reply is received	The "📶" icon blinks.	Move your location, then try again.	–
	The "📶" icon displayed.	Push [PTT] to re-register the transceiver to the system. Wait for a while, or change your location. Check that the LTE line is established.	
	The operator is away from the transceiver, or the transceiver is turned OFF.	Wait until the operator is back, or ask your system manager.	
"Key lock" is displayed when a key is pushed	The Key Lock function is turned ON.	Turn OFF the Key Lock function.	p. 1-7
The charging indicator blinks orange, or alternately blinks orange and green	The battery pack is not properly inserted.	Insert the battery pack properly.	pp. 5-6, 5-7
	Charging the battery pack outside of the chargeable temperature range.	Charge the battery pack in the chargeable temperature range. 10°C to 40°C (+50°F to +104°F)	p. 5-5
	Loose connection of charging transceivers.	Clean the charger terminals.	–
	The transceiver power is ON while charging.	Turn OFF the power while charging.	
The charging indicator is OFF even the battery pack is inserted to the charger.	The battery pack is not properly inserted.	Properly insert the battery pack.	pp. 5-6, 5-7
The "📶" icon blinks, or "Connecting..." is displayed (standby screen is not displayed)	The transceiver is located out of the service area.	Change your location, then try again.	–
		Reboot the transceiver.	
The deleted recorded audio still exists	The battery pack was removed before the recorded audio was deleted from memory.	Remove the battery pack after "Power OFF..." is displayed.	p. 3-7
The recorded audio is lost	The battery pack was removed before the recorded audio was stored into memory.		
Pairing failed	The transceiver is not in the Pairing mode.	Enter the Pairing mode.	p. 5-13
	There are other active Bluetooth devices nearby.	Stop using other Bluetooth devices.	–
		Use the transceiver away from other Bluetooth devices.	–
	There are other devices that are operating in the 2.4 GHz band.	Use the transceiver away from the other devices, or stop using those devices.	–

6 FOR YOUR REFERENCE

■ Troubleshooting (continued)

PROBLEM	POSSIBLE CAUSE	SOLUTION	REFERENCE
"Pairing list is full" is displayed in the Pairing screen.	Number of paired devices exceeds the maximum number.	Delete a Bluetooth device from the pairing list.	p. 5-21
The call was suddenly cut off /Noise is heard	Too far from the Bluetooth device. (When using a Bluetooth headset)	Get closer to the Bluetooth device. ① The communication range of Bluetooth is approximately 10 meters (33 feet).	—
	Electromagnetic interference from other electronic devices.	Use the transceiver away from the other devices, or stop using those devices.	—
No audio output from IP501H after the Bluetooth connection with BC-218 is disconnected.	IP501H is in the Bluetooth signal detecting sequence. (Approximately 20 seconds)	Push the Bluetooth button on the BC-218 to disconnect the Bluetooth device, then turn OFF the BC-218 power.	—
No sound comes from the earphone that is connected to the VS-3.	The volume level is set too low.	Increase the VS-3's volume level.	p. 5-11
		Increase the IP501H's volume level. (When "Bluetooth Synchronous Volume" is set to valid)	pp. 1-3, 4-6
	Loose earphone plug connection.	Firmly insert the plug.	p. 1-4

■ Specifications

◇ General

Operating temperature range:	-10°C ~ +60°C (14°F ~ 140°F)
Humidity:	Less than 25 ~ 85% (Without condensation)
Dimensions:	59 (W) × 95 (H) × 32 (D) mm (Projections not included, with BP-272)
Weight:	Approximately 240 g (Including antenna and BP-272)
Power supply:	7.4 V (with BP-272 Li-ion battery pack: 1880 mAh)
IP code:	IP67/MIL-STD810G
Operating time:	17 hours (TX:RX:Standby=5:5:90, with BP-272)

◇ Audio

Codec:	G.726
AF output power:	More than 0.4 W (Internal speaker 16 Ω 10% distortion) More than 0.2 W (External speaker 8 Ω 10% distortion)
AF output impedance:	Internal speaker 16 Ω/External speaker 8 Ω

◇ 3G (W-CDMA)

Frequency band:	
USA version	B2, B5
Europe version	B1, B8
Transmission power:	24 dBm (Typical)

◇ LTE

Frequency band:	
USA version	FDD-LTE B2, B4, B5, B17
Europe version	FDD-LTE B1, B3, B7, B8, B20 TD-LTE B38, B40
Transmission power:	25.7 dBm (Maximum)

◇ GNSS

GPS:	Supported 1575.42 MHz
GLONASS:	Supported 1598.0625 ~ 1605.375 MHz

◇ Bluetooth

Frequency range:	2402 ~ 2480 MHz
Transmission power:	7.3 dBm (Maximum)
Version:	Bluetooth Ver.2.1+EDR
Profile:	HFP, HSP, SPP

■ Specifications (continued)

◇ **BC-202IP2** RAPID CHARGER (Option)

Input voltage:	DC 12 ~ 16 V (Used with the supplied BC-123S power adapter)
Operating temperature range:	10°C ~ 40°C (50°F ~ 104°F)
Weight:	Approximately 105 g (Power adapter not included)
Dimensions:	88.0 (W) × 47.5 (H) × 72.5 (D) mm (Projections not included)

◇ **BC-211** MULTI CHARGER (Option)

Input voltage:	DC 12 ~ 16 V (Used with the supplied BC-157S power adapter)
Operating temperature range:	10°C ~ 40°C (50°F ~ 104°F)
Weight:	Approximately 1200 g (Power adapter not included)
Dimensions:	303.2 (W) × 78.2 (H) × 179.7 (D) mm (Projections not included)

◇ **BC-218** RAPID CHARGER (Option)

Input voltage:	DC 12 ~ 16 V (Used with the supplied BC-207S power adapter)
Operating temperature range:	10°C ~ 40°C (50°F ~ 104°F)
Weight:	Approximately 140 g (Power adapter not included)
Dimensions:	87.2 (W) × 48.7 (H) × 77 (D) mm (Projections not included)
Bluetooth version:	Bluetooth Ver.2.1+EDR
Bluetooth profile:	HFP, HSP, A2DP, AVRCP (Only HFP and HSP are guaranteed)

INDEX

A		E	
[Address] key	1-6, 2-4, 3-5, 4-2	Echo Cancellor	4-6
Antenna	1-2	Emergency Call	3-6, 3-12
Audio output level adjustment	1-3		
B		F	
Back Light function	2-3, 4-5	"F" blinks	1-5
Battery pack	1-2	Firmware update	1-5, 4-4
Attaching/Detaching	1-2	Full duplex mode	2-3
Battery life	5-3, 5-5	[FUNC] key	1-5, 1-6
BC-202IP2	5-6		
BC-211	5-6	H	
BC-218	5-7, 5-8, 5-10, 5-13, 5-15	Hand strap	1-2
Belt clip	1-2, 5-7	HM-215	5-10, 5-15
Bluetooth	4-4, 5-9		
Auto Connect	4-6	I	
Connecting and disconnecting	5-15	ICCID	4-7
Delete Bluetooth Device	4-7, 5-21		
Echo Cancellor	4-6	K	
Echo Cancellor Voice Delay	4-6	Key Lock function	1-7, 6-2
Echo Cancellor Input Gain	4-6	Key-Touch Beep	4-5
Initialize Bluetooth Unit	4-7	Key-Touch Beep Volume	4-5
Initializing pairing list	5-22, 5-23, 5-24		
Noise Cancellor	4-6	L	
One Touch PTT	4-7	LC-185	5-28
Pairing	5-12	Log	2-5, 4-4
Pairing failed	6-2	Lone Worker function	3-13
Power Save	4-6	LTE Unit Version	4-7
PTT Beep	4-7		
Search Bluetooth Device	4-7	M	
Synchronous Volume	5-8, 5-11, 4-6, 6-3	MBA-7	5-25, 2-26
Unit Version	4-7	MBF-1	5-25, 2-26
		Message Call	3-2, 3-6
C		Microphone sensitivity	4-5
Call at Stand-by	4-5, 4-6	Mute	3-6
[Call history] key	1-6, 2-5, 3-3, 3-12, 4-3		
Calling Notice Tone	4-4	N	
Calls cannot be made	6-2	No power comes ON	6-2
Charging time	5-3	No reply is received	6-2
Charging indicator	5-6, 5-7	No sound output	6-2
[CLR/LOCK] key	1-6	Noise Cancellor	4-5
Contrast	4-5	Notification Beep Volume	4-5
Courtesy Beep	4-4	Notification Type	4-4
		Number of Notifications	4-4
D		O	
Deleting history logs	2-6	One Touch PTT	4-6
Destination ID	2-4, 4-6	Optional products	5-2
		[Option] key	3-6, 3-12
		Out of Range Notice	4-5

INDEX

P

P-Bell function	3-10
Pocket Beep function	3-10
PTT Lock	4-5

R

Receive Buffer	4-5
Received Call Notification Volume.....	4-4
Received Call Notification	4-4
Recording	
Recording function	2-3, 3-7, 4-7
Play.....	3-6, 3-8
Recording Call type	4-7
Record data	2-3, 3-7, 6-2
Deleting recorded audio	3-9
Remaining battery capacity	1-5, 1-7
Reset	4-4

S

SET mode	4-2, 4-4
Sidetone.....	4-5
Sidetone Volume	4-5
Silent mode	3-12
Simplex mode	2-3
Status Call	3-3

T

Talkgroup	3-4, 3-5
Tone	
Failure Tone	4-4
Receive Notification Tone	4-4
Success Tone	4-4
Turning OFF the power	2-3
Turning ON the power	1-3
Tx Inhibit	4-5
[TX/RX] indicator	2-2

V

Vibration function	2-2
VOX function.....	3-11, 4-5
VOX Threshold	4-5
VS-3	5-11, 5-16

Count on us!

