

Welcome to the world of Hytera and thank you for purchasing this product. This manual includes a description of the functions and step-by-step procedures for use. It also includes a troubleshooting guide. To avoid bodily injury or property loss caused by incorrect operation, please carefully read the *Safety Information Booklet* before use.

This manual is applicable to the following product:

PD662i Digital Portable Radio

DIGITAL PORTABLE RADIO

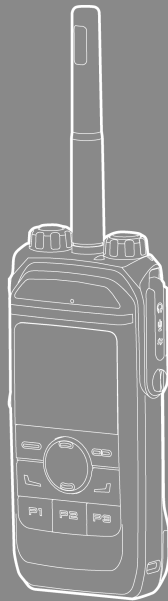

## Copyright Information

Hytera is the trademark or registered trademark of Hytera Communications Corporation Limited (the Company) in the People's Republic of China (PRC) and/or other countries or areas. The Company retains the ownership of its trademarks and product names. All other trademarks and/or product names that may be used in this manual are properties of their respective owners.

The product described in this manual may include the Company's computer programs stored in memory or other media. Laws in PRC and/or other countries or areas protect the exclusive rights of the Company with respect to its computer programs. The purchase of this product shall not be deemed to grant, either directly or by implication, any rights to the purchaser regarding the Company's computer programs. The Company's computer programs may not be copied, modified, distributed, decompiled, or reverse-engineered in any manner without the prior written consent of the Company.

## Disclaimer

The Company endeavors to achieve the accuracy and completeness of this manual, but no warranty of accuracy or reliability is given. All the specifications and designs are subject to change without notice due to continuous technological development. No part of this manual may be

copied, modified, translated, or distributed in any manner without the prior written consent of the Company.

We do not guarantee, for any particular purpose, the accuracy, validity, timeliness, legitimacy or completeness of the third-party products and contents involved in this manual.

If you have any suggestions or would like to receive more information, please visit our website at: <http://www.hytera.com>.

## FCC Statement

This equipment has been tested and found to comply with the limits for a Class B digital device, pursuant to part 15 of FCC Rules. These limits are designed to provide reasonable protection against harmful interference in a residential installation. This equipment generates and can radiate radio frequency energy. If not installed and used in accordance with the instructions, it may cause harmful interference to radio communications. However, there is no guarantee that interference will not occur in a particular installation. Verification of harmful interference by this equipment to radio or television reception can be determined by turning it off and then on. The user is encouraged to try to correct the interference by one or more of the following measures:

- Reorient or relocate the receiving antenna. Increase the separation between the equipment and receiver.

- Connect the equipment into an outlet on a different circuit to that of the receiver's outlet.
- Consult the dealer or an experienced radio/TV technician for help.

Operation is subject to the following two conditions:

- This device may not cause harmful interference.
- This device must accept any interference received, including interference that may cause undesired operation.

Note: Changes or modifications to this unit not expressly approved by the party responsible for compliance could void the user's authority to operate the equipment.

## Compliance with RF Exposure Standards

The radio complies with the following RF energy exposure standards and guidelines:

- United States Federal Communications Commission, Code of Federal Regulations; 47 CFR § 1.1307, 1.1310 and 2.1093
- American National Standards Institute (ANSI) / Institute of Electrical and Electronic Engineers (IEEE) C95. 1:2005; Canada RSS102 Issue 5 March 2015
- Institute of Electrical and Electronic Engineers (IEEE) C95.1:2005 Edition

## RF Exposure Compliance and Control Guidelines and Operating Instructions

To control your exposure and ensure compliance with the occupational/controlled environmental exposure limits, always adhere to the following procedures.

Guidelines:

- Do not remove the RF Exposure Label from the device.
- User awareness instructions should accompany device when transferred to other users.
- Do not use this device if the operational requirements described herein are not met.

Operating Instructions:

- Transmit no more than the rated duty factor of 50% of the time. To transmit (talk), press the **Push-To-Talk (PTT)** key. To receive calls, release the **PTT** key. Transmitting 50% of the time, or less, is important because the radio generates measurable RF energy only when transmitting (in terms of measuring for standards compliance).
- Keep the radio unit at least 2.5 cm away from the face. Keeping the radio at the proper distance is important as RF exposure decreases with distance from the antenna. The antenna should be kept away from the face and eyes.

- When worn on the body, always place the radio in an approved holder, holster, case, or body harness or by use of the correct clip for this product. Use of non-approved accessories may result in exposure levels which exceed the FCC's occupational/controlled environmental RF exposure limits.
- Use of non-approved antennas, batteries, and accessories causes the radio to exceed the FCC RF exposure guidelines.
- Contact your local dealer for the product's optional accessories.

## IC Statement

The device has been tested and complies with SAR limits, users can obtain Canadian information on RF exposure and compliance.

Après examen de ce matériel aux conformité aux limites DAS et/ou aux limites d'intensité de champ RF, les utilisateurs peuvent sur l'exposition aux radiofréquences et la conformité and compliance d'acquérir les informations correspondantes

This device complies with Industry Canada license-exempt RSS standard(s). Operation is subject to the following two conditions:

- This device may not cause harmful interference.
- This device must accept any interference received, including interference that may cause undesired operation.

Le présent appareil est conforme aux CNR d'Industrie Canada applicables aux appareils radio exempts de licence. L'exploitation est autorisée aux deux conditions suivantes: (1) l'appareil ne doit pas produire de brouillage, et (2) l'utilisateur de l'appareil doit accepter tout brouillage radioélectrique subi, même si le brouillage est susceptible d'en compromettre le fonctionnement

## EU Regulatory Conformance

As certified by the qualified laboratory, the product is in compliance with the essential requirements and other relevant provisions of the following directives: 2014/53/EU, 2006/66/EC, 2011/65/EU, and 2012/19/EU.

Please note that the above information is applicable to EU countries only.

# Contents



<b>Documentation Conventions</b> .....	3	Selecting a Zone and Channel .....	9
<b>Packing List</b> .....	4	<b>Status Indications</b> .....	10
<b>Product Overview</b> .....	5	LCD Icons .....	10
Product Controls .....	5	LED Indications .....	12
Programmable Keys .....	5	<b>Call Services</b> .....	13
<b>Before Use</b> .....	6	Group Call .....	13
Charging the Battery .....	6	Private Call .....	15
Attaching the Battery .....	6	Phone Call .....	16
Attaching the Antenna .....	7	All Call .....	18
Attaching the Belt Clip .....	7	Broadcast Call (Trunking Only) .....	19
Attaching the Audio Accessories .....	7	Include Call (Trunking Only) .....	20
<b>Basic Operations</b> .....	8	Call on Analog Channel .....	20
Turning the Radio On or Off .....	8	<b>Message Services</b> .....	21
Adjusting the Volume .....	8	Viewing Messages .....	21
Checking the Battery Power .....	9	Sending Messages .....	21
Locking or Unlocking Keys and Knobs .....	9	Deleting Messages .....	21
Switching the Operation Mode .....	9	<b>Supplementary Features</b> .....	22

Basic Settings .....	23
Contact Management .....	24
Audio Optimization .....	25
MIC & SPK .....	26
One Touch Call/Menu .....	27
Scan .....	27
Hunt .....	28
Roam .....	29
Talk Around .....	30
Time-out Timer .....	30
VOX .....	30
Call Priority .....	30
DGNA .....	30
GPS .....	31
Work Order .....	32
Control Services .....	32
Analog Services .....	33
Personal Safety Services .....	34

Communication Security Services .....	35
<b>Troubleshooting .....</b>	<b>37</b>
<b>Care and Cleaning .....</b>	<b>39</b>
Product Care .....	39
Product Cleaning .....	39
<b>Optional Accessories .....</b>	<b>39</b>
<b>Abbreviations .....</b>	<b>39</b>

## Documentation Conventions

### Icon Conventions

Icon	Description
 <b>Note</b>	Indicates references that can further describe the related topics.
 <b>Caution</b>	Indicates situations that could cause data loss or equipment damage.

### Notation Conventions

Item	Description	Example
<b>Boldface</b>	Denotes menus, tabs, parameter names, window names, dialogue names, and hardware buttons.	To save the configuration, click <b>Apply</b> .
		The <b>Log Level Settings</b> dialogue appears.
		Press the <b>PTT</b> key.

Item	Description	Example
" "	Denotes messages, directories, file names, folder names, and parameter values.	The screen displays "Invalid Battery!".
		Open "PDT_PSS.exe".
		Go to "D:/opt/local".
		In the <b>Port</b> text box, enter "22".
>	Directs you to access a multi-level menu.	Go to <b>File &gt; New</b> .
<i>Italic</i>	Denotes document titles.	For details about using the DWS, refer to <i>Dispatch Workstation User Guide</i> .
Courier New	Denotes commands and their execution results.	To set the IP address, run the following command: <code>vos-cmd - m name IP</code>

## Packing List

Please unpack carefully and check that all items listed below are received. If any item is missing or damaged, please contact your dealer.

Item	Quantity (PCS)	Item	Quantity (PCS)
Radio	1	Antenna	1
Battery	1	Belt Clip	1
Charger	1	Strap	1
Power Adapter	1	Documentation Kit	1



### Note

Check whether the frequency band marked on the antenna label matches that on the radio label. If not, please contact your dealer.



## Product Overview

### Product Controls

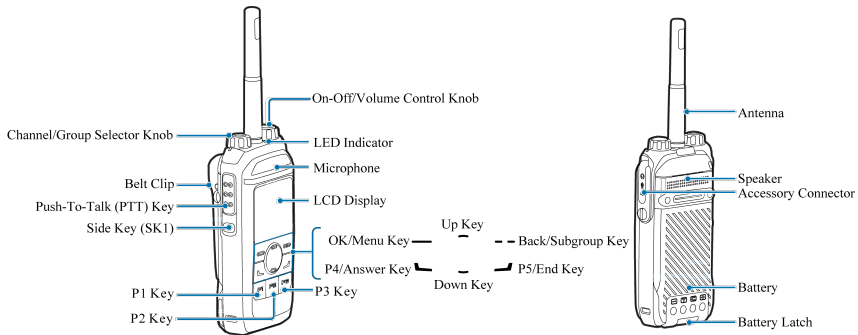

### Programmable Keys

You can request your dealer to program the following keys as shortcuts to radio features: **SK1**, **Up** key, **Down** key, **P1** key, **P2** key, **P3** key, **P4** key, and **P5** key. Please consult your dealer for assignable radio features.

## Before Use

### Charging the Battery

#### Caution

- Use the approved charger to charge the battery.
- Read the *Safety Information Booklet* before charging.

Before initial use, fully charge the battery to ensure optimum performance.

To charge the battery, do as follows:

1. Insert the output connector of the power adapter into the port on the back of the charger.
2. Plug the power adapter into a power outlet that is off.
3. Place the battery into the charger, and then switch the power outlet on.

To determine the charging status, check the light-emitting diode (LED) indicator on the charger according to the following table:

LED Indicator	Charging Status
Flashes red slowly	The battery fails to make proper contact with the charger.
Glows red	The battery is charging.

LED Indicator	Charging Status
Glows orange	The battery is charged to 90% or above.
Glows green	The battery is fully charged.
Flashes red rapidly	The battery fails to be charged.

If the LED indicator flashes red slowly, take the battery out of the charger, and then place it into the charger for proper contact.

If the LED indicator flashes red rapidly, please contact your dealer to check whether the battery or power adapter is damaged.

#### Note

You can also charge the radio with battery attached. It is recommended that your radio remain powered off during charging.

### Attaching the Battery

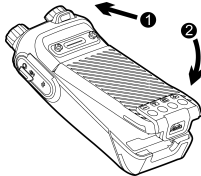

---

 **Note**

To remove the battery, make sure that the radio is turned off, and then slide the battery latch upwards to unlock the battery.

---

## Attaching the Antenna



---

 **Caution**

Do not hold the radio by the antenna, as it may reduce the radio performance and life span of the antenna.

---

## Attaching the Belt Clip

1. Use a Phillips screwdriver to turn the screws counter-clockwise on the back of the radio and remove them.
2. Align the screw holes on the belt clip with those on the back of the radio.
3. Put the screws back in place as shown below, and use the Phillips screwdriver to turn them clockwise until hand tight.

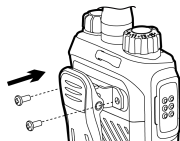

---

## Attaching the Audio Accessories

 **Caution**

For optimal waterproof and dustproof performance, do close the accessory connector cover and fasten the screw when no accessory is attached.

---

1. Loosen the screw fixing the accessory connector cover as shown below, and open the cover.



2. Align the accessory plug with the accessory connector, and then tighten the screw on the accessory plug as shown below.



## Basic Operations

### Turning the Radio On or Off

ON

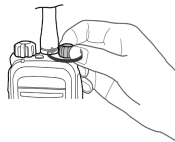

OFF

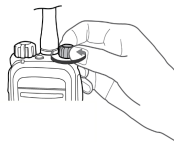



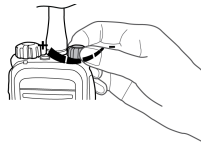

### Adjusting the Volume



## Checking the Battery Power

To check the battery power, press and hold the preprogrammed **Battery Power Indicator** key. The following table lists the battery power indications. The icon  indicates that the battery runs low. In this case, please recharge or replace the battery.

Icon	LED Indication/Tone
	The LED indicator glows green.
	The LED indicator glows orange.
	The LED indicator glows red.
	The LED indicator glows red and an alert tone sounds.

## Locking or Unlocking Keys and Knobs

When the keypad is not in use, it is recommended that you lock it to avoid unintended operations.

To lock or unlock the keypad, press the preprogrammed **Keypad Lock** key.

To allow the keypad to be locked automatically, enable the Keypad Lock feature as follows:

1. Go to **Menu > Settings > Radio Set > Keypad Lock**.
2. Select **Enable**, and then set **Delay Time** by pressing the **Up** or **Down** key.

In addition, you can go to **Menu > Settings > Radio Set > Optional Key** to set whether the corresponding keys and knobs still work when the keypad is locked.

## Switching the Operation Mode

The radio can operate in conventional mode or trunking mode. In conventional mode, you can receive and transmit voice and data after selecting the required channel. In trunking mode, you can receive and transmit voice and data after the radio registers successfully.

To switch the operation mode, do one of the following:

- Go to **Menu > Mode > Manual Switch**, select the required mode, and then press the **OK/Menu** key.
- Press the preprogrammed **Operation Mode Switch** key.

To allow the radio to automatically switch to a mode based on signal strength in trunking mode, go to **Menu > Mode > Auto Switch**, and then select **Enable**.

## Selecting a Zone and Channel

In conventional mode, the radio receives and transmits data and voice on the selected channel. A zone is a group of channels within the same operational area. Before selecting a channel, make sure that the current zone contains the channel.

To select a zone, do one of the following:

- Go to **Menu > Zone**, and then select the required zone.
- Press the preprogrammed **Zone Up** or **Zone Down** key.

To select a channel, do one of the following:

- Rotate the **Channel Selector** knob.
- Press the preprogrammed **Channel Up** or **Channel Down** key.

## Status Indications

### LCD Icons









The following tables list icons that may appear on the radio's liquid-crystal display (LCD).













#### Operation Mode Icons

Icon	Radio Status
<b>DM</b>	Direct Mode: The radio transmits and receives directly.
<b>RM</b>	Repeater Mode: The radio transmits and receives through a repeater.
<b>TDMA</b>	TDMA Direct Mode: If one time slot is occupied, the radio can transmit and receive through the other time slot.
<b>TM-DW</b>	Trunking Mode - Digital Wide: The radio operates under multiple BSs connected through the network.





Icon	Radio Status
<b>TM-DL</b>	Trunking Mode - Digital Local: The radio operates under a single BS.
	The Mode Automatic Switch feature is enabled.

#### Basic Status Icons





Icon	Radio Status
	The Dual-Tone Multi-Frequency (DTMF) keypad is enabled.
	The number of bars indicates the charge left in the battery.
	There is no signal in conventional or TM-DW mode.
	The number of bars indicates the signal strength in conventional or TM-DW mode.
	There is no signal in TM-DL mode.
	The number of bars indicates the signal strength in TM-DL mode.
	The radio is set at high power.
	The radio is set at low power.



Icon	Radio Status
	An accessory is connected.
	The Global Positioning System (GPS) feature is enabled, and the radio receives GPS data.
	The GPS feature is enabled, but the radio receives no GPS data.
	The radio is in emergency mode.
	The radio is roaming.
	The Scrambler or Encrypt feature is enabled.
	The radio is scanning or hunting.
	The radio stays on a non-priority channel.
P <sub>1</sub>	The radio stays on priority channel 1.
P <sub>2</sub>	The radio stays on priority channel 2.
	The Voice Operated Transmit (VOX) feature is enabled.
	The Monitor feature is enabled.
	The speaker is turned on.
	The radio operates in silent mode.
	The Loudness and Quality Optimizer (LQO) feature is enabled.

## Short Data Icons

Icon	Radio Status
	There is/are unread short message(s).
	The Inbox is full.
	There is/are unread status message(s).
	There is/are unread work order(s).
	The work order list is full.

## Call Icons

Icon	Radio Status
	There is/are alert call(s).
	There is/are missed call(s).
	The Call Divert feature is enabled.
	A private call is in progress or a private contact is on the contact list.
	A group call is in progress or a group contact is on the contact list.

Icon	Radio Status
	An all call is in progress.
	An include call is in progress.

LED Indicator	Radio Status
	a period, you can press and hold the <b>PTT</b> key and speak.

## LED Indications

LED Indicator	Radio Status
Flashes green	Being turned on.
Flashes green slowly	Standby in trunking mode.
Glow green	Receiving.
Glow red	Transmitting.
Flashes red	Establishing a call in trunking mode. This indication is applicable to the calling radio.
Flashes orange slowly	Scanning, hunting, or roaming.
Flashes orange rapidly	<ul style="list-style-type: none"> <li>● Conventional mode: Working in emergency mode.</li> <li>● Trunking mode: Establishing a Full Off Air Call Set-Up (FOACSU) call. This indication is applicable to the called radio.</li> </ul>
Glow orange	Call hang time: No voice is being transmitted or received on the channel during a call. Within such



## Call Services

When you are speaking during a call, keep the microphone about 2.5 to 5 cm away from your mouth. This ensures optimal voice quality on the receiving radio.







### Group Call

A group call is a call from an individual user in a group to all the other members in the group.

#### Initiating a Group Call



The following table describes how to initiate a group call in conventional mode and trunking mode.

Mode	Manner	Operation
Conventional	Preset Contact	<ol style="list-style-type: none"><li>1. Rotate the <b>Channel Selector</b> knob to select the channel associated with the target group contact.</li><li>2. Press and hold the <b>PTT</b> key.</li></ol>
	Contact List / Favorites	<ol style="list-style-type: none"><li>1. Go to <b>Menu &gt; Contact &gt; Contact List / Favorites</b>.</li><li>2. Select the target group contact.</li><li>3. Press and hold the <b>PTT</b> key.</li></ol>
Trunking	Preset Contact	<ol style="list-style-type: none"><li>1. Rotate the <b>Group Selector</b> knob to select the target group contact.</li><li>2. Press and hold the <b>PTT</b> key.</li></ol>
	Favorites	<ol style="list-style-type: none"><li>1. Go to <b>Menu &gt; Contact &gt; Favorites</b>.</li><li>2. Select the target group contact.</li><li>3. Press  or press and hold</li></ol>

Mode	Manner	Operation
		the <b>PTT</b> key.
	Subgroup	<ol style="list-style-type: none"> <li>1. Press the preprogrammed <b>Subgroup</b> key or go to <b>Menu &gt; Subgroup</b>.</li> <li>2. Select the required subgroup, and then select <b>Member</b>.</li> <li>3. Select the target group contact.</li> <li>4. Press  or press and hold the <b>PTT</b> key.</li> </ol>
	ReDial/BackDial Call Log	<ol style="list-style-type: none"> <li>1. From the home screen, press  or  (if preprogrammed as the <b>ReDial</b> or <b>BackDial</b> key).</li> <li>2. Select the target group contact from the list.</li> <li>3. Press  or press and hold the <b>PTT</b> key.</li> </ol>

Mode	Manner	Operation
	Call Log	<ol style="list-style-type: none"> <li>1. Go to <b>Menu &gt; Call Logs &gt; Outgoing/Incoming/Missed &gt; Outgoing List / Incoming List / Missed List</b>.</li> <li>2. Select the target group contact.</li> <li>3. Press  or press and hold the <b>PTT</b> key.</li> </ol>

## Receiving a Group Call

When you receive a group call, the radio displays . The call is established automatically. In trunking mode, the radio displays  after the call is established successfully.

## Ending a Group Call

A group call automatically ends when the call hang time expires.

In trunking mode, a group call also ends in any of the following cases:

- The calling party ends the call by pressing the **End** key or preprogrammed **Clear Down** key.
- The call duration exceeds the period preset by your dealer.
- A preemptive or emergency call interrupts the call.
- The base station signal is lost.





## Private Call

A private call is a call from an individual user to another individual user.

### Initiating a Private Call

The following table describes how to initiate a private call in conventional mode and trunking mode.

Mode	Manner	Operation
Conventional	Preset Contact	<ol style="list-style-type: none"> <li>1. Rotate the <b>Channel Selector</b> knob to select the channel associated with the target private contact.</li> <li>2. Press and hold the <b>PTT</b> key.</li> </ol>
	Contact List / Favorites	<ol style="list-style-type: none"> <li>1. Go to <b>Menu &gt; Contact &gt; Contact List / Favorites</b>.</li> <li>2. Select the target private contact.</li> <li>3. Press and hold the <b>PTT</b> key.</li> </ol>

Mode	Manner	Operation
Trunking	Preset Contact	<ol style="list-style-type: none"> <li>1. Rotate the <b>Group Selector</b> knob to select the target private contact.</li> <li>2. Press and hold the <b>PTT</b> key to initiate the call.</li> </ol>
	Favorites / Private Contact	<ol style="list-style-type: none"> <li>1. Go to <b>Menu &gt; Contact &gt; Favorites / Private Contact</b>.</li> <li>2. Select the target private contact.</li> <li>3. Press  or press and hold the <b>PTT</b> key.</li> </ol>
	ReDial/BackDial Call Log	<ol style="list-style-type: none"> <li>1. From the home screen, press  or  (if preprogrammed as the <b>ReDial</b> or <b>BackDial</b> key).</li> <li>2. Select the target private contact from the list.</li> <li>3. Press  or press and hold the <b>PTT</b> key.</li> </ol>
Conventional/ Trunking	Call Log	<ol style="list-style-type: none"> <li>1. Go to <b>Menu &gt; Call Logs &gt; Outgoing</b></li> </ol>

Mode	Manner	Operation
		<p>/Incoming/Missed &gt;  <b>Outgoing List / Incoming List / Missed List.</b></p> <ol style="list-style-type: none"> <li>Select the target private contact.</li> <li>Press  or press and hold the <b>PTT</b> key.</li> </ol>



## Receiving a Private Call

### Conventional Mode

When you receive a private call, the radio displays . The call is established automatically.

### Trunking Mode

When receiving an Off Air Call Set-Up (OACSU) private call, you can listen to it without any operation.

When receiving a FOACSU private call, press  or press and hold the **PTT** key to answer the call. After the call is established successfully, the radio displays .

### Ending a Private Call

A private call automatically ends when the call hang time expires.

In trunking mode, a private call also ends in any of the following cases:

- The calling or called party ends the call by pressing the **End** key or preprogrammed **Clear Down** key.
- The call duration exceeds the period preset by your dealer.
- A preemptive or emergency call interrupts the call.
- The base station signal is lost.





## Phone Call

In conventional mode, you can initiate or receive a call to or from a Public Switched Telephone Network (PSTN) terminal. The One-Key Connect feature must be enabled by your dealer for you to initiate or receive a phone call in conventional mode. In trunking mode, you can initiate or receive a call to or from a PSTN or Private Automatic Branch eXchange (PABX) terminal.

### Initiating a Phone Call

The following table describes how to initiate a phone call in conventional mode and trunking mode.

Mode	Manner	Operation
Conventional	Contact List	<ol style="list-style-type: none"> <li>Go to <b>Menu &gt; Phone &gt; DTMF Keypad</b>, and then select <b>Enable</b>.</li> <li>Press  to transmit the connect code.</li> </ol>

Mode	Manner	Operation
		<ol style="list-style-type: none"> <li>Go to <b>Menu &gt; Phone &gt; Phone Contact</b>, and then select the target phone contact.</li> <li>Press and hold the <b>PTT</b> key.</li> </ol>
Trunking	Preset Contact	<ol style="list-style-type: none"> <li>Rotate the <b>Group Selector</b> knob to select the target phone contact.</li> <li>Press and hold the <b>PTT</b> key.</li> </ol>
	Favorites / Private Contact	<ol style="list-style-type: none"> <li>Go to <b>Menu &gt; Contact &gt; Favorites / Private Contact</b>.</li> <li>Select the target phone contact.</li> <li>Press  or press and hold the <b>PTT</b> key.</li> </ol>
	Call Log	<ol style="list-style-type: none"> <li>Go to <b>Menu &gt; Call Logs &gt; Outgoing/Incoming/Missed &gt; Outgoing List / Incoming List / Missed List</b>.</li> <li>Select the target phone contact.</li> <li>Press  or press and hold the <b>PTT</b> key.</li> </ol>
	ReDial/BackDial Call Log	<ol style="list-style-type: none"> <li>From the home screen, press  or  (if preprogrammed as the <b>ReDial</b> or <b>BackDial</b> key).</li> </ol>

Mode	Manner	Operation
		<ol style="list-style-type: none"> <li>Select the target phone contact from the list.</li> <li>Press  or press and hold the <b>PTT</b> key.</li> </ol>



## Receiving a Phone Call

### Conventional Mode

When receiving a call from a phone, you need to transmit the preprogrammed connect code to access the telephone system as described in Initiating a Phone Call.

After the radio accesses the telephone system successfully, the call is established automatically.

### Trunking Mode

When you receive a call from a phone, the radio displays . To answer the call, press  or press and hold the **PTT** key within the preset period. After the call is established successfully, the radio displays .

### Ending a Phone Call

In conventional mode, a phone call ends in any of the following cases:

- You transmit the preprogrammed disconnect code in the same way as the connect code.
- The phone user hangs up.

In trunking mode, a phone call ends in any of the following cases:

- The calling or called party ends the call.
- The call duration exceeds the period preset by your dealer.
- A preemptive or emergency call interrupts the call.
- The base station signal is lost.

## All Call

### Conventional Mode

An all call is a call from an individual user to all other users on the current channel.

### Trunking Mode

An all call is a call from an individual user to all other users in a specific BS, area, or system.

According to whether the called party can respond, the all call is classified into the following two types:

- Broadcast All Call: The called party cannot respond to the call.
- General All Call: The called party can respond to the call.

To set the type, go to **Menu > Settings > Radio Set > All Call**, and then select **Broadcast Call** or **General Call**.

#### Note

The radio must be authorized by your dealer for you to initiate an all call.

## Initiating an All Call

The following table describes how to initiate an all call in conventional mode and trunking mode.

Mode	Manner	Operation
Conventional	Preset Contact	<ol style="list-style-type: none"> <li>1. Rotate the <b>Channel Selector</b> knob to select the channel associated with the all call contact.</li> <li>2. Press and hold the <b>PTT</b> key.</li> </ol>
	Contact List	<ol style="list-style-type: none"> <li>1. Go to <b>Menu &gt; Contact &gt; Contact List</b>.</li> <li>2. Select the all call contact.</li> <li>3. Press and hold the <b>PPT</b> key.</li> </ol>
Trunking	One Touch Call	Press the preprogrammed <b>One Touch Call/Menu</b> key.
	ReDial Call Log	<ol style="list-style-type: none"> <li>1. From the home screen, press  (if preprogrammed as the <b>ReDial</b> key).</li> </ol>

Mode	Manner	Operation
		2. Select the all call log from the list. 3. Press  or press and hold the <b>PTT</b> key.

## Receiving an All Call

When you receive an all call, the radio displays , and the call is established automatically.

## Ending an All Call

In conventional mode, an all call ends when the Time-out Timer (TOT) expires.

In trunking mode, an all call ends in any of the following cases:

- The calling party ends the call.
- The call duration exceeds the period preset by your dealer.
- A preemptive or emergency call interrupts the call.
- The base station signal is lost.



## Broadcast Call (Trunking Only)





A broadcast call is a special group call to which the called party cannot respond. The radio must be authorized by your dealer for you to initiate a

broadcast call.



## Initiating a Broadcast Call

The following table describes how to initiate a broadcast call.

Manner	Operation
Favorites	1. Go to <b>Menu &gt; Contact &gt; Favorites</b> . 2. Select the target group contact, and then press the <b>OK/Menu</b> key. 3. Select <b>Call Type</b> , and then select <b>Broadcast Call</b> . 4. Press  or press and hold the <b>PTT</b> key.
Subgroup	1. Press the preprogrammed <b>Subgroup</b> key or go to <b>Menu &gt; Subgroup</b> . 2. Select the required subgroup, and then select <b>Member</b> . 3. Select the target group contact, and then press the <b>OK/Menu</b> key. 4. Select <b>Call Type</b> , and then select <b>Broadcast Call</b> . 5. Press  or press and hold the <b>PTT</b> key.
Call Log	1. Go to <b>Menu &gt; Call Logs &gt; Outgoing/Incoming/Missed &gt; Outgoing List / Incoming List / Missed List</b> . 2. Select the target group contact, and then press the <b>OK/Menu</b> key.

Manner	Operation
	<ol style="list-style-type: none"> <li>3. Select <b>Call Type</b>, and then select <b>Broadcast Call</b>.</li> <li>4. Press  or press and hold the <b>PTT</b> key.</li> </ol>
ReDial/BackDial Call Log	<ol style="list-style-type: none"> <li>1. From the home screen, press  or  (if preprogrammed as the <b>ReDial</b> or <b>BackDial</b> key).</li> <li>2. Select the target group contact from the list, and then press the <b>OK/Menu</b> key.</li> <li>3. Select <b>Call Type</b>, and then select <b>Broadcast Call</b>.</li> <li>4. Press  or press and hold the <b>PTT</b> key.</li> </ol>

## Receiving a Broadcast Call

When you receive a broadcast call, the radio displays . The call is established automatically. In trunking mode, the radio displays  after the call is established successfully.

## Ending a Broadcast Call

A broadcast call ends in any of the following cases:

- The calling party ends the call.
- The call duration exceeds the period preset by your dealer.
- A preemptive or emergency call interrupts the call.
- The base station signal is lost.

## Include Call (Trunking Only)

An include call is a call initiated to another group in call hang time of an ongoing group call, so that the group joins the ongoing call. The radio must be authorized by your dealer for you to initiate an include call.

For operations of the include call, see "Group Call" on page 13.

## Call on Analog Channel

In conventional mode, you can initiate or receive a call on an analog channel with or without signaling.

## Call Without Signaling

A call without signaling is a call initiated to all the other users on an analog channel without signaling.

To initiate a call without signaling, do as follows:

1. Rotate the **Channel Selector** knob to select the required channel.
2. Press and hold the **PTT** key, and speak into the microphone.

## Call With Signaling

On an analog channel with signaling, you can initiate a call to a specific contact on the channel. Do as follows:

1. Rotate the **Channel Selector** knob to select the required channel.
2. Press the **OK/Menu** key, and go to **Contact > Contact List**.



3. Select the target contact.
4. Press and hold the **PTT** key, and speak into the microphone.

## Message Services

The Message feature allows you to send a quick text and receive, forward or delete a message.

### Viewing Messages

To view newly received messages, directly press the **OK/Menu** key.

To view received messages or sent messages, do as follows:

1. Go to **Menu > Message > InBox/OutBox > Inbox List / Outbox List**.
2. Select the required message.

### Sending Messages

You can send quick text messages, forward messages from the InBox or OutBox, and resend messages from the OutBox.

#### Sending Quick Text Messages

A quick text message is a frequently used message predefined by your dealer. To send quick text messages, do as follows:

1. Press the **OK/Menu** key, and then go to **Message > Quick Text**.
2. Select the required quick text, and then press the **OK/Menu** key.

3. Select **Send**, and then select the target contact.
4. Press the **OK/Menu** key.

### Forwarding Messages

To forward messages from the InBox or OutBox, do as follows:

1. Press the **OK/Menu** key.
2. Go to **Message > InBox/OutBox > Inbox List / Outbox List**.
3. Select the required message, and then press the **OK/Menu** key.
4. Select **Forward**, and then select the target contact.
5. Press the **OK/Menu** key.

### Resending Messages

To resend messages from the OutBox, do as follows:

1. Press the **OK/Menu** key.
2. Go to **Message > OutBox > Outbox List**.
3. Select the required message, and then press the **OK/Menu** key.
4. Select **ReSend**, and then press the **OK/Menu** key.

### Deleting Messages

To delete a message from the InBox or OutBox, do as follows:

1. Press the **OK/Menu** key.
2. Go to **Message > InBox/OutBox > Inbox List / Outbox List**.
3. Select the required message, and then press the **OK/Menu** key.

4. Select **Delete**, and then press the **OK/Menu** key.

To delete all messages from the InBox or OutBox, do as follows:

1. Press the **OK/Menu** key.
2. Go to **Message > InBox/OutBox**.
3. Select **Delete All**, and then press the **OK/Menu** key.

## Supplementary Features

The supplementary features of the radio vary with the operation mode. For details, see the following table.

Feature	Conventional		Trunking
	Digital	Analog	
Basic Settings	√	√	√
Contact Management	√	√	√
Mic Automatic Gain Control (AGC)	√	√	√
Treble Boost	√	√	√
3-Band Equalizer	√	√	√
LQO	√	√	√
Audio Feedback Suppression	√	×	√
MIC & SPK	√	√	√

Feature	Conventional		Trunking
	Digital	Analog	
One Touch Call/Menu	√	√	√
Scan	√	√	×
Hunt	×	×	√
Roam	√	×	√
Talk Around	√	√	×
Time-out Timer	√	√	√
VOX	√	√	√
Call Priority	×	×	√
Dynamic Group Number Assignment (DGNA)	×	×	√
GPS	√	√	√
Work Order	√	×	√
Control Services	√	×	×
Analog Services	×	√	×
Personal Security Services	√	√	√
Encrypt	√	×	√
Scrambler	×	√	×

Feature	Conventional		Trunking
	Digital	Analog	
Erasing Data in Emergency	√	×	√
Stun	×	×	√
Kill	×	×	√

## Basic Settings

You can go to **Menu > Settings > Radio Set** and then do the following operations:

If you want to...	Then...
Set the language	Select <b>Language</b> , and then select the required language.
Check whether the battery is approved by Hytera	Select <b>Battery</b> . If the battery is an approved one, the radio will display "Certificated Battery".

If you want to...	Then...
Set the backlight	Select <b>Backlight</b> , and select one of the following as required: <ul style="list-style-type: none"> <li>● <b>Off</b>: The backlight remains off.</li> <li>● <b>On</b>: The backlight remains on.</li> <li>● <b>Timed</b>: The backlight automatically goes out if no operation or activity is performed within the preset period.</li> </ul>
Adjust the brightness of the backlight	Select <b>Brightness</b> , and then press the <b>Up</b> or <b>Down</b> key.
Set the LCD mode	Select <b>Day/Night</b> , and then select <b>Day Mode</b> or <b>Night Mode</b> .
Turn on or off the LED indication	Select <b>LED</b> , and then select <b>Enable</b> or <b>Disable</b> .
Turn on or off the silent mode	Go to <b>Tone &gt; Radio Silent</b> , and then select <b>Silent On</b> or <b>Silent Off</b> .
Turn on or off a specific tone	<ol style="list-style-type: none"> <li>1. Select <b>Tone</b>, and then select the required tone.</li> <li>2. Select <b>On/Off</b>, and then select <b>Enable</b> or <b>Disable</b>.</li> </ol>
Adjust the volume of a specific tone	<ol style="list-style-type: none"> <li>1. Select <b>Tone</b>, and then select the required tone.</li> </ol>

If you want to...	Then...
	2. Select <b>Tone Volume</b> , and then select the required level.
Turn on or off the Vibration feature	Go to <b>Vibration &gt; On/Off</b> , and then select <b>Enable</b> or <b>Disable</b> .
Set a specific vibration type	<ol style="list-style-type: none"> <li>1. Select <b>Vibration</b>, and then select the required vibration type.</li> <li>2. Select <b>Settings</b>, and then set <b>Duration</b>, <b>Cycles</b>, or <b>Interval Time</b> as required.</li> </ol>
Adjust the power level	<p>Select <b>Power Level</b>, and then select one of the following as required:</p> <ul style="list-style-type: none"> <li>● <b>Hight Power</b>: Enables communication with distant radios but consumes more battery power.</li> <li>● <b>Low Power</b>: Enables communication with close radios and saves battery power.</li> </ul>
Set the time zone	<ol style="list-style-type: none"> <li>1. Go to <b>Date &amp; Time &gt; Time Zone</b>, and then press the <b>OK/Menu</b> key,</li> <li>2. Press the <b>Up</b> or <b>Down</b> key to change the time zone, and then press the <b>OK/Menu</b> key.</li> </ol>
Set the time format (trunking)	Go to <b>Date &amp; Time &gt; Time Format</b> , and

If you want to...	Then...
only)	then select <b>24 Hour</b> or <b>12 Hour</b> .
Check the remaining rental period	Go to <b>Rent &gt; Rent Query</b> .
Turn off all visible and audible indications	Select <b>Covert Mode</b> , and then select <b>On</b> .
Allow or disallow the radio to send its alias during voice transmission	Select <b>Send Alias</b> , and then select <b>On</b> or <b>Off</b> .

## Contact Management

### Adding a Contact to the Favorites List

To add a frequently used contact to the **Favorites** list, do as follows:

- In conventional mode, go to **Menu > Contact > Favorites > Add Contact**, and then select the required contact.
- In trunking mode, go to **Menu > Contact > Favorites > Folder Management > Add Contact**, and then select the required contact.

## Deleting a Contact

To delete a contact from Favorites list, Phone Contact list (conventional only), and Private Contact list (trunking only), do as follows:

1. Select the required contact from the corresponding list.
2. Select **Del Contact** or **Delete**, and then press the **OK/Menu** key.

## Audio Optimization

The features described in this section help optimize voice quality.

### Turning the Mic AGC feature On or Off

The Mic AGC feature allows the radio to automatically keep the microphone gain within a proper range during transmission. This provides optimized voice with proper volume for the receiving party.

To turn this feature on or off, go to **Menu > Settings > Audio Set > Digital Mic AGC / Analog Mic AGC**, and then select **On** or **Off**.

### Turning the Treble Boost feature On or Off

The Treble Boost feature allows the radio to output louder voice for better audio clarity.

To turn this feature on or off, go to **Menu > Settings > Audio Set > Audio Optimization > Treble Boost**, and then select **On** or **Off**.



#### Note

With this feature enabled, the LQO feature and 3-Band Equalizer feature are unavailable.

---

## Setting the 3-Band Equalizer Feature

The 3-band Equalizer feature allows the radio to automatically adjust the sound effect of received voice according to preset frequency gains.

To turn this feature on or off, go to **Menu > Settings > Audio Set > Audio Optimization > 3-Band Equalizer > Equalizer Switch**, and then select **On** or **Off**.

To set the low, mid, or high frequency gain, do as follows:

1. Go to **Menu > Settings > Audio Set > Audio Optimization > 3-Band Equalizer > Low Freq. Gain / Mid Freq. Gain / High Freq. Gain**, and then press the **OK/Menu** key.
2. Press the **Up** or **Down** key to change the value, and then press the **OK/Menu** key.

It is recommended that you set the frequency gains according to the following table:

Scenario	Low Frequency Gain (dB)	Mid Frequency Gain (dB)	High Frequency Gain (dB)
Square	0	3	5
Indoor	3.5	1.5	-1.5
Downtown	2	2	8

## Turning the LQO Feature On or Off

The LQO feature allows the radio to automatically adjust the volume and effect of received voice in different environments.

To turn this feature on or off, go to **Menu > Settings > Audio Set > LQO**, and then select **On** or **Off**.

## Turning the Audio Feedback Suppression Feature On or Off

The Audio Feedback Suppression feature helps reduce the noises arising from short-distance communication.

To turn this feature on or off, go to **Menu > Settings > Audio Set > Audio Feedback Suppressors**, and then select **On** or **Off**.

## MIC & SPK

The MIC & SPK feature allows you to select the microphone and speaker used by the radio for transmitting and receiving voice respectively.

### Selecting the Microphone

To set whether the radio uses the external or internal microphone, go to **Menu > Settings > Radio Set > MIC & SPK > MIC Selection**, and then select one of the following as required:

- **Follow PTT**: When you transmit by pressing and holding the radio's PTT key, the radio uses the internal microphone; otherwise, it uses the external microphone.
- **Only Internal**: The radio uses only the internal microphone.
- **Only External**: The radio uses only the external microphone.
- **External First**: When an audio accessory is connected, the radio uses the external microphone; otherwise, it uses the internal microphone.

### Selecting the Speaker

To set whether the radio uses the external or internal speaker, go to **Menu > Settings > Radio Set > MIC & SPK > SPK Selection**, and then select one of the following as required:

- **External First**: When an audio accessory is connected, the radio uses the external speaker; otherwise, it uses the internal speaker.

- **INTR & EXTR:** The radio uses both the internal speaker and external speaker.
- **Only External:** The radio uses only the external speaker.

## One Touch Call/Menu

The One Touch Call/Menu feature allows you to press the preprogrammed **One Touch Call/Menu** key to quickly access a service assigned by your dealer. The services available for assignment are as follows:

Service Type	Description
Voice and Data Services in Conventional Mode	Analog Channel: To call a 5-tone or 2-tone contact.
	Digital Channel:
	<ul style="list-style-type: none"> <li>● To initiate a group call or send a quick text or GPS message to the group contact.</li> <li>● To initiate a private call, radio check, remote monitor, radio enable, or radio disable or send a quick text message, alert call, or GPS message to the private contact.</li> <li>● To initiate an all call to the all call contact.</li> </ul>

Service Type	Description
Voice and Data Services in Trunking Mode	<ul style="list-style-type: none"> <li>● To initiate a private, emergency, or preemptive call or send a text or status message to the private contact.</li> <li>● To initiate a group, broadcast, emergency, preemptive, preemptive broadcast, or emergency broadcast call or send a text or status message to the group contact.</li> <li>● To initiate an all call to the all call contact.</li> </ul>
Menu	To directly access the designated menu. Check with your dealer for specific menus.

To initiate a one touch call on the digital channel in conventional mode, you need to press the **PTT** key after pressing the preprogrammed **One Touch Call/Menu** key.

## Scan

The Scan feature allows you to listen to activities on other channels, keeping track of your team members. With this feature enabled, the radio searches the scan list preset for the current channel and stays on a channel with activities.

## Turning the Scan Feature On or Off

To turn the Scan feature on or off, go to **Menu > Scan > Scan On/Off**, and then select **On** or **Off**.

With the Scan feature enabled, the radio displays , and the LED indicator slowly flashes orange. When detecting activities on a channel, the radio stays on it, and the LED indicator glows green.



### Note

If you do not want to listen to the activities on the channel, press the preprogrammed **Nuisance Temporary Delete** key to temporarily remove the channel from the scan list.

## Adding a Channel to a Scan List

1. Go to **Menu > Scan > Scan List**, and then select the required scan list.
2. Select **Edit/View**, and then select **Add CH**.
3. Select the required channel.

## Setting a Priority Channel

You can set a channel in the scan list as priority channel 1 or 2, which will be scanned more frequently than a non-priority channel.

To set a priority channel, do as follows:

1. Go to **Menu > Scan > Scan List**, and then select the required scan list.
2. Select **Edit/View**, and then select the required channel.

3. Select **Edit Prio CH > Set PrioCH-1 / Set PrioCH-2**.

To change a priority channel to a non-priority channel, select the priority channel marked with  $P_1$  or  $P_2$ , and then select **Edit Prio CH > Disable PrioCH**.

## Deleting a Channel from a Scan List

1. Go to **Menu > Scan > Scan List**, and then select the required scan list.
2. Select **Edit/View**, and then select the required channel.
3. Select **Delete CH**.

## Hunt

In trunking mode, the radio must register with a BS for normal operation. The Hunt feature allows the radio to:

- Hunt through the Trunked Station Control Channels (TSCCs) for an available BS for registration.
- Always work under a BS with higher signal strength after registration, ensuring smooth communication.

## Selecting the Mode for Fixed TSCC Hunt

If the radio is preprogrammed by your dealer to use the Fixed TSCC hunt for registration, you can go to **Menu > Hunt > TSCC Hunt**, and then select one of the following modes as required:



- **Comprehensive Hunt:** allows the radio to hunt all TSCCs within the preset frequency range.
- **Short Hunt:** allows the radio to hunt the TSCCs in the fixed TSCC list predefined by your dealer.
- **Team Hunt:** allows the radio to hunt the TSCCs in the team hunt list predefined by your dealer.

## Turning the Background Hunt Feature On or Off

The Background Hunt feature allows the radio in standby mode to keep detecting the signal strength of the current BS. If the signal strength goes below the preset threshold, the radio switches to another BS with higher signal strength.

To turn this feature on or off, go to **Menu > Hunt > Background Hunt**, and then select **Enable** or **Disable**.

## Turning the Homestation Hunt Feature On or Off

In an overlapping area, it is recommended that you request the dealer to set the frequently used channel as the homestation channel and enable the Homestation Hunt feature. In this case, the radio operating on another channel switches back to the homestation channel after the signal strength of the homestation channel reaches the preset threshold.

To turn this feature on or off, go to **Menu > Hunt > Homestation Hunt**, and then select **Enable** or **Disable**.

## Turning the Handover Feature On or Off

The Handover feature prevents call drops or discontinuous voice caused by low signal strength. With this feature enabled, the radio automatically switches to another BS with higher signal strength if the signal strength of the current BS goes below the preset threshold during a call.

To turn this feature on or off, go to **Menu > Hunt > Handover > Handover On/Off**, and then select **Enable** or **Disable**.

To set whether handover is allowed during transmission, go to **Menu > Hunt > Handover > Handover in Tx**, and then select **Enable** or **Disable**.

## Roam

The Roam feature allows you to enjoy seamless communication across sites or networks.

In conventional mode, you can turn this feature on or off as follows: Go to **Menu > Roam > Roam On/Off**, and then select **On** or **Off**.

In trunking mode, this feature needs to be turned on or off by your dealer.

## Talk Around

The Talk Around feature allows your radio to continue transmitting and receiving when the repeater is not operating, or when your radio is out of the repeater's coverage but within other radio's coverage.

To turn this feature on or off, go to **Menu > Settings > Radio Set > Talk Around**, and then select **Enable** or **Disable**.

## Time-out Timer

The Time-out Timer (TOT) feature allows the radio to automatically stop transmission and keep beeping when the period preset by your dealer expires. To stop beeping, release the **PTT** key. You need to wait for a certain period (also preset by your dealer) to initiate transmission again.

This feature aims to prevent a radio user from occupying a channel for an extended period and to avoid potential radio damage caused by overheating.

## VOX

The VOX feature allows you to transmit voice without pressing and holding the **PTT** key. The radio automatically transmits voice when the volume reaches the preset level.

To turn this feature on or off, go to **Menu > Settings > Radio Set > VOX > On/Off**, and then select **On** or **Off**. When this feature is enabled, the radio displays .

To set the sensitivity of the external or internal microphone, go to **Menu > Settings > Radio Set > VOX > Gain Level > External/Internal**, and then select the appropriate level. A higher gain level indicates lower sensitivity, which requires higher volume for triggering transmission.

## Call Priority

The Call Priority feature allows you to set the priority of voice services except emergency call. When all channels are occupied, the call requests are put in a queue according to their priorities. During queuing, the radio displays "Call Queued".

To set the priority, go to **Menu > Settings > Radio Set > Priority**, and then select one of the following as required: **Low**, **Medium**, **High**, and **Preemption**.

The **Preemption** option is available only when the Preemptive Call feature is enabled by your dealer. A preemptive call does not need to queue.

## DGNA

The DGNA feature allows you to join a dynamic group added by the authorized dispatcher over the air interface according to temporary task

requirements. The dispatcher can also delete the dynamic group from your radio.

The radio displays "DGNA Success!" when the dynamic group is added successfully and "DGNA Deleted" when the dynamic group is deleted. The added dynamic group is saved in a dynamic subgroup list under Subgroup on your radio.

## GPS

The GPS feature allows you to view your location information, query location information of another radio user, and send your location information to the dispatch station or another radio.

### Turning the GPS Feature On or Off

In conventional mode, go to **Menu > Accessories > GPS > GPS On/Off**, and then select **On** or **Off**.

In trunking mode, the GPS feature needs to be turned on or off by your dealer.

### Viewing Location Information

You can view location information of your radio and another radio.

#### Viewing Location Information of Your Radio

Go to **Menu > Accessories > GPS > Position**.

#### Viewing Location Information of Another Radio

- **Trunking Mode**

To view location information of the nearest radio in a designated group, go to **Menu > Accessories > GPS > Query Neighbors > Group Contact**, and then select the required group contact.

- **Digital Channel in Conventional Mode**

To view the location information of another radio, go to **Menu > Accessories > GPS > Query Location > Contact List**, and select the required private contact.

### Sending Location Information

In conventional mode, you can send your location information to a target contact as follows:

1. Go to **Menu > Accessories > GPS > Position**, and then press the **OK/Menu** key.
2. Select **Contact List**, and then select the target contact.

### Turning the Voice with GPS Feature On or Off

The Voice with GPS feature allows the radio to automatically send GPS data during voice transmission.

To turn this feature on or off, go to **Menu > Accessories > GPS > Voice with GPS**, and then select **On** or **Off**.

## Work Order

The Work Order feature allows you to receive a task from the dispatcher and report the latest task state to the dispatcher at each stage of the task.

### Viewing a Task

To view a task in any state, go to **Menu > Work Orders > All Task**, select the required task, and then select **Details**.

To view a task that has not been processed, go to **Menu > Work Orders > New Task**, select the required task, and then select **Details**.

After a task is processed and the task state is updated, the task is moved from the **New Task** list to the list of the corresponding state. To view a task in a specific state, do as follows:

1. Go to **Menu > Work Orders**, and then select the corresponding list.
2. Select the required task, and then select **Details**.

### Reporting the Task State

To report the latest state of a task, do as follows:

1. Select the required task as described above.
2. Select the state to be reported, and then press the **OK/Menu** key.

## Control Services

On the digital channel in conventional mode, you can initiate the following control services to a private contact.

Feature	Description	Operation
Alert Call	Allows you to alert a private contact to call you back.	To trigger the corresponding feature, do as follows: <ol style="list-style-type: none"><li>1. Go to <b>Menu &gt; Contact &gt; Favorites / Contact List</b>.</li><li>2. Select the target private contact.</li><li>3. Go to <b>Ctrl Services &gt; Alert Call / Radio Check / Remote Monitor / Radio Enable / Radio Disable</b>.</li></ol>
Radio Check	Allows you to check whether another radio is operating on the current channel without disturbing that radio user.	
Remote Monitor	Allows you to remotely monitor activities surrounding another radio.	
Radio Enable	Allows you to remotely enable a disabled radio for normal operation.	

Feature	Description	Operation
Radio Disable	Allows you to remotely disable another radio.	

## Analog Services

The following features are available only on an analog channel in conventional mode.

### Turning the Compandor Feature On or Off

The Compandor feature allows the radio to compress transmitted voice signals, which suppresses ambient noise and improves audio quality.

To turn this feature on or off, go to **Menu > Settings > Radio Set > Compandor**, and then select **Enable** or **Disable**.

### Turning the Monitor Feature On or Off

The Monitor feature allows the radio to receive weak signals.

To turn this feature on, press the preprogrammed **Monitor** key or press and hold the preprogrammed **Monitor Momentary** key. In this case, the radio displays .

To turn this feature off, press the preprogrammed **Monitor** key again or release the preprogrammed **Monitor Momentary** key.

### Turning the Squelch Off Feature On or Off

The Squelch Off feature allows the radio's speaker to keep turned on no matter whether the squelch condition is satisfied.

To turn this feature on, press the preprogrammed **Squelch Off** key or press and hold the preprogrammed **Squelch Off Momentary** key. In this case, the radio displays .

To turn this feature off, press the preprogrammed **Squelch Off** key again or release the preprogrammed **Squelch Off Momentary** key.

### Setting the Squelch Level

The squelch level refers to the squelch threshold required for the radio's speaker to be turned on.

To set the squelch level, go to **Menu > Settings > Radio Set > Squelch**, and then select **Open**, **Normal**, or **Tight** (from low to high) as required.

Generally, a higher squelch level requires higher signal strength. If the squelch level is set to **Open**, the speaker will always keep turned on.

## Setting the CTCSS/CDCSS Feature

The Continuous Tone-Coded Squelch System (CTCSS) / Continuous Digital-Coded Squelch System (CDCSS) feature allows the radio to filter out unwanted voice on the current channel. With this feature enabled by your dealer, the radio's speaker is turned on only when the CTCSS/CDCSS code received matches the CTCSS/CDCSS code set for the radio.

To set the CTCSS/CDCSS type and code, go to **Menu > Programming > Channel > TX CTCSS/CDCSS / RX CTCSS/CDCSS**.

## Personal Safety Services

The features described in this section ensure personal safety.

### Using the Emergency Feature

The Emergency feature allows you to ask for help from your companion or the control centre in case of emergency.

In emergency mode, the radio gives different indications according to the preset emergency type. The available emergency types are as follows:

Emergency Type	Description
Siren Only	The radio sounds shrill alarm tones with visible indications.

Emergency Type	Description
Regular	The radio gives audible and visible indications.
Silent	The radio gives no audible or visible indication, and you cannot listen to a received call.
Silent w/ Voice	The radio gives no audible or visible indication, but you can listen to a received call.
Alarm w/ Siren	The radio sends an alarm and sounds shrill alarm tones with visible indications.

In addition, you can request your dealer to set one of the following emergency modes:

Emergency Mode	Description
Alarm	Allows you to send an emergency alarm.
Call	Allows you to initiate an emergency call.
Alarm W/Call	Allows you to send an emergency alarm and initiate an emergency call.

The three emergency modes can be combined with any of the following emergency types: **Regular**, **Silent**, and **Siren w/ Voice**.

## Triggering the Emergency Mode

To trigger the emergency mode, press the preprogrammed **Emergency On** key. The radio then enters the preset emergency mode with or without indications depending on the preset emergency type.

In trunking mode, you can also initiate an emergency call as follows:

1. Go to **Menu > Contact > Favorites**, and then select the target group contact.
2. Select **Call Type**, and then select **Emergency Call**.
3. Press and hold the **PTT** key to initiate the call.

If the Call to Follow feature is enabled by your dealer, the radio will transmit automatically. You can directly speak into the microphone in the preset period.

## Exiting the Emergency Mode

To exit the emergency mode (as the initiating party) or emergency alert mode (as the receiving party), press the preprogrammed **Emergency Off** key or turn off the radio.

## Turning the Man Down Feature On or Off

The Man Down feature allows the radio to enter the emergency mode when it tilts at an angle greater than the specified angle or stays motionless for a preset period.

To turn this feature on or off, go to **Menu > Settings > Radio Set > Man Down**, and then select **Enable** or **Disable**.

## Turning the Lone Worker Feature On or Off

The Lone Worker feature allows the radio to enter the emergency mode when no operation is detected for a preset period.

To turn this feature on or off, go to **Menu > Settings > Radio Set > Lone Worker**, and then select **Enable** or **Disable**.

## Communication Security Services

The features described in this section ensure communication security.

### Using the Encrypt Feature

The Encrypt feature prevents eavesdropping and ensures communication privacy. It allows the radio to automatically encrypt transmitted voice or data. Only the receiving radio with the same key value or ID can decrypt the voice or data.

### Turning the Encrypt Feature On or Off

Go to **Menu > Settings > Radio Set > Encrypt > On/Off**, and then select **On** or **Off**.

### Selecting the Encrypt Key (Conventional Only)

In conventional mode, you can select an encrypt key. Do as follows:

1. Go to **Menu > Settings > Radio Set > Encrypt > Key List**.
2. Select the required key, and then select **Select**.

### Selecting Encrypted Service (Trunking Only)

In trunking mode, you can set which kind of service will be encrypted. Do as follows:

1. Go to **Menu > Settings > Radio Set > Encrypt > Encrypt Service**.
2. Select **Only Voice**, **Only Data**, or **Voice and Data** as required.

### Turning the Scrambler Feature On or Off

The Scrambler feature prevents eavesdropping and ensures communication privacy. It allows the radio to invert the frequency spectrum of transmitted audio signals. Only the receiving radio with the same scrambler setting can restore the audio signals.

To enable or disable this feature, go to **Menu > Settings > Radio Set > Scrambler**, and then select **Enable** or **Disable**.

### Erasing Data in Emergency

In case of emergency, you can erase encryption data, for example, the encrypt key, from the radio, preventing the data from unauthorized access.

To erase the data, press the **SKI** and **PTT** key by turns twice, and make sure the press interval is less than 1.5 seconds. Then, press **SKI** to confirm.

### Restoring the Stunned Radio

When being stunned, the radio displays "Radio Stunned!" In this case, you cannot initiate call and message services.

To restore normal operation, request your dealer to program the radio or send a Revive command. When being enabled by a Revive command, the radio displays "Revive Success!"

### Restoring the Killed Radio

When being killed, the radio displays "Radio Killed!" In this case, you can only power on or off the radio.

To restore normal operation, request your dealer to burn the radio.



## Troubleshooting

Phenomena	Analysis	Solution
You cannot turn on the radio.	The battery may be installed improperly.	Remove and reattach the battery.
	The battery power may run out.	Recharge or replace the battery.
	The battery may suffer from poor contact caused by dirty or damaged battery contacts.	Clean the battery contacts or replace the battery.
During receiving, the voice is weak or intermittent.	The battery voltage may be low.	Recharge or replace the battery.
	The volume level may be low.	Increase the volume.
	The antenna may be loose or may be installed incorrectly.	Turn off the radio, and then remove and reattach the antenna.
	The speaker may be blocked.	Clean the surface of the speaker.
You cannot communicate with other group members.	The frequency or signaling type may be inconsistent with that of other members.	Verify that your TX/RX frequency and signaling type are correct.
	The channel type (digital or analog) may be set incorrectly.	Verify that you are on the correct digital or analog channel.
	You may be too far away from other members.	Move towards other members.
You hear unknown voices or noise.	You may be interrupted by radios using the same frequency.	Change the frequency, or adjust the squelch level.
	The radio in analog mode may be set with no signaling.	Request your dealer to set signaling for the current channel to avoid interference.

Phenomena	Analysis	Solution
You are unable to hear anyone because of too much noise and hiss.	You may be too far away from other members.	Move towards other members.
	You may be in an unfavourable position. For example, your communication may be blocked by high buildings or blocked in an underground area.	Move to an open and flat area, restart the radio, and try again.
	It may be the result of external disturbance (such as electromagnetic interference).	Stay away from equipment that may cause interference.
You cannot use the keys.	The keypad may not work temporarily.	Restart the radio.
The LCD does not display any information.	The LCD may not work temporarily.	Restart the radio.

If the above solutions cannot fix your problems, or you may have some other queries, please contact your dealer for more technical support.

## Care and Cleaning

To guarantee optimal performance as well as a long service life of the product, please follow these tips.

### Product Care

- Do not pierce or scrape the product.
- Keep the product far away from substances that can corrode the circuitry.
- Do not hold the product by the antenna or earpiece cable.
- Close the accessory connector cover when no accessory is in use.

### Product Cleaning

#### Caution

Turn off the product and remove the battery before cleaning.

- Clean up the dust and fine particles on the product surface and charging piece with a clean and dry lint-free cloth or a brush regularly.
- Use neutral cleanser and a non-woven fabric to clean the keys, knobs, and front case after long-time use. Do not use chemical preparations such as stain removers, alcohol, sprays or oil preparations, so as to avoid surface case damage.
- Make sure the product is completely dry before use.

## Optional Accessories

Contact your local dealer for the optional accessories used with the product.

#### Caution

Use the approved accessories only; otherwise, we will not be liable for any loss or damage arising out of the use of any unauthorised accessories.

## Abbreviations

Abbreviation	Full Name
AGC	Automatic Gain Control
BS	Base Station
CDCSS	Continuous Digital-coded Squelch System
CTCSS	Continuous Tone-coded Squelch System
DGNA	Dynamic Group Number Assignment
DTMF	Dual-tone Multi-frequency
FOACSU	Full Off Air Call Set-up
GPS	Global Positioning System
LCD	Liquid-crystal display

<b>Abbreviation</b>	<b>Full Name</b>
LED	Light-emitting diode
LQO	Loudness and Quality Optimizer
OACSU	Off Air Call Set-up
PTT	Push-to-Talk
SK	Side Key
TM-DL	Trunking Mode - Digital Local
TM-DW	Trunking Mode - Digital Wide
TOT	Time-out Timer
TSCC	Trunked Station Control Channel
VOX	Voice Operated Transmit