



INSTRUCTION MANUAL

VHF TRANSCEIVERS

IC-F3260
Series

UHF TRANSCEIVERS

IC-F4260
Series

This device complies with Part 15 of the FCC Rules. Operation is subject to the condition that this device does not cause harmful interference.

Icom Inc.



The photo shows the UHF transceiver.

IMPORTANT

READ ALL INSTRUCTIONS carefully and completely before using the transceiver.

SAVE THIS INSTRUCTION MANUAL — This instruction manual contains important operating instructions for the **IC-F3261DT/DS, IC-F3263DT/DS VHF TRANSCEIVERS** and **IC-F4261DT/DS, IC-F4263DT/DS UHF TRANSCEIVERS**.

This instruction manual includes some functions which are usable only when they are preset by your dealer. Ask your dealer for details.

 See the operating guide for details of IDAS™ NXDN™, BIIS, MDC and LTR® system operations. Ask your dealer for details.

Icom, Icom Inc. and the Icom logo are registered trademarks of Icom Incorporated (Japan) in Japan, the United States, the United Kingdom, Germany, France, Spain, Russia and/or other countries.



IDAS is trademark of Icom Incorporated (Japan).

NXDN is a trademark of Icom Incorporated and JVC KENWOOD Corporation.

LTR is a registered trademark of the E.F.Johnson Technologies, INC. in the United States.

All other products or brands are registered trademarks or trademarks of their respective holders.

EXPLICIT DEFINITIONS

WORD	DEFINITION
 DANGER!	Personal death, serious injury or an explosion may occur.
 WARNING!	Personal injury, fire hazard or electric shock may occur.
CAUTION	Equipment damage may occur.
NOTE	If disregarded, inconvenience only. No risk of personal injury, fire or electric shock.

VOICE CODING TECHNOLOGY

The AMBE+2™ voice coding Technology embodied in this product is protected by intellectual property rights including patent rights, copyrights and trade secrets of Digital Voice Systems, Inc. This voice coding Technology is licensed solely for use within this Communications Equipment. The user of this Technology is explicitly prohibited from attempting to extract, remove, decompile, reverse engineer, or disassemble the Object Code, or in any other way convert the Object Code into a human-readable form. U.S. Patent Nos.

#5,870,405, #5,826,222, #5,754,974, #5,701,390, #5,715,365, #5,649,050, #5,630,011, #5,581,656, #5,517,511, #5,491,772, #5,247,579, #5,226,084 and #5,195,166.

PRECAUTIONS

⚠ DANGER! NEVER short the terminals of the battery pack.

⚠ DANGER! Use and charge only specified Icom battery packs with Icom radios or Icom chargers. Only Icom battery packs are tested and approved for use with Icom radios or charged with Icom chargers. Using third-party or counterfeit battery packs or chargers may cause smoke, fire, or cause the battery to burst.

⚠ WARNING! NEVER hold the transceiver so that the antenna is very close to, or touching exposed parts of the body, especially the face or eyes, while transmitting. The transceiver will perform best if the microphone is 5 to 10 cm (2 to 4 inches) away from the lips and the transceiver is vertical.

⚠ WARNING! NEVER operate the transceiver with a headset or other audio accessories at high volume levels. Hearing experts advise against continuous high volume operation. If you experience a ringing in your ears, reduce the volume level or discontinue use.

⚠ WARNING! NEVER operate the transceiver while driving a vehicle. Safe driving requires your full attention—anything less may result in an accident.

CAUTION: MAKE SURE the flexible antenna, battery pack and jack cover are securely attached to the transceiver, and that the antenna and battery pack are dry before attachment. Exposing the inside of the transceiver to dust or water will result in serious damage to the transceiver.

DO NOT operate the transceiver near unshielded electrical blasting caps or in an explosive atmosphere.

DO NOT push [PTT] when not actually intending to transmit.

DO NOT use or place the transceiver in direct sunlight or in areas with temperatures below -30°C (-22°F) or above $+60^{\circ}\text{C}$ ($+140^{\circ}\text{F}$).

The basic operations, transmission and reception of the transceiver are guaranteed within the specified operating temperature range. However, the LCD display may not be operate correctly, or show an indication in the case of long hours of operation, or after being placed in extremely cold areas.

DO NOT modify the transceiver. The transceiver warranty does not cover any problems caused by unauthorized modification.

DO NOT use harsh solvents such as benzine or alcohol when cleaning, as they will damage the transceiver surfaces.

BE CAREFUL! The transceiver will become hot when operating it continuously for long periods of time.

PRECAUTIONS (Continued)

BE CAREFUL! The transceiver meets IP67 requirements for dust-tight and waterproof protection. However, once the transceiver has been dropped, dust-tight and waterproof protection cannot be guaranteed because of possible damage to the transceiver's case or the waterproof seal.

Even when the transceiver power is OFF, a slight current still flows in the circuits. Remove the battery pack or batteries from the transceiver when not using it for a long time. Otherwise, the installed battery pack or batteries will become exhausted, and will need to be recharged or replaced.

MAKE SURE to turn OFF the transceiver power before connecting the supplied/optional equipment.

For IC-F4261, IC-F4263

- The GPS receiver may not work if the transceiver transmits near the 510 MHz. This is made in the internal circuit and does not indicate a transceiver malfunction.

FCC INFORMATION

• FOR CLASS A UNINTENTIONAL RADIATORS:

This equipment has been tested and found to comply with the limits for a Class A digital device, pursuant to part 15 of the FCC Rules. These limits are designed to provide reasonable protection against harmful interference when the equipment is operated in a commercial environment. This equipment generates, uses, and can radiate radio frequency energy and, if not installed and used in accordance with the instruction manual, may cause harmful interference to radio communications. Operation of this equipment in a residential area is likely to cause harmful interference in which case the user will be required to correct the interference at his own expense.

CAUTION: Changes or modifications to this transceiver, not expressly approved by Icom Inc., could void your authority to operate this transceiver under FCC regulations.

TABLE OF CONTENTS

IMPORTANT	i	■ Automatic Key Lock function	18
EXPLICIT DEFINITIONS	i	■ Priority A channel selection.....	18
VOICE CODING TECHNOLOGY	i	4 BATTERY CHARGING	19–23
PRECAUTIONS.....	ii	■ Caution.....	19
FCC INFORMATION	iii	■ Optional battery chargers.....	21
TABLE OF CONTENTS.....	iv	5 BATTERY CASE.....	24–26
1 ACCESSORIES.....	1–3	■ BP-240 optional battery case.....	24
■ Supplied accessories	1	■ BP-261 optional battery case.....	25
■ Accessory attachments.....	1	6 SWIVEL BELT CLIP	27–28
2 PANEL DESCRIPTION.....	4	■ MB-93 contents	27
■ Front panel	4	■ To attach	27
■ Function display	5	■ To detach	28
■ Programmable function keys.....	6	7 SPEAKER MICROPHONE.....	29
3 BASIC OPERATION.....	11–18	■ Optional HM-184.....	29
■ Turning power ON	11	■ To attach	29
■ Channel selection	12	8 OPTIONS.....	30–31
■ Call procedure.....	13	9 SAFETY TRAINING INFORMATION.....	32–33
■ Receiving and transmitting.....	13		
■ User set mode.....	16		
■ Scrambler function	16		
■ Stun function	16		
■ Emergency transmission.....	17		
■ Man Down Emergency Call.....	17		

1

2

3

4

5

6

7

8

9

■ Supplied accessories

The following accessories are supplied.

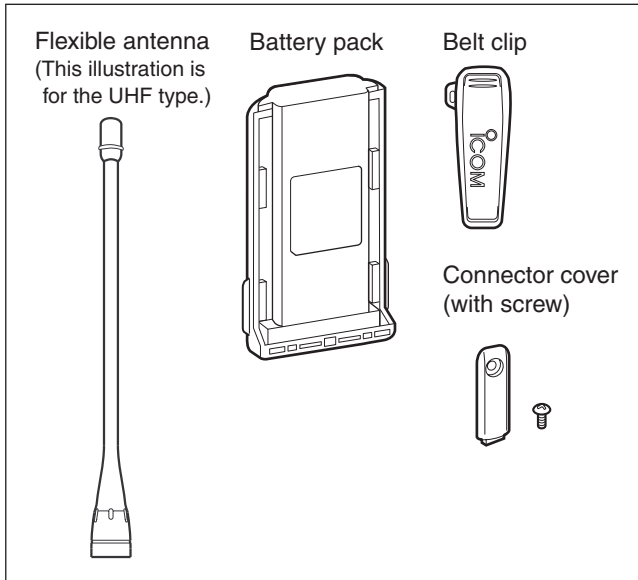

/// **NOTE:** Some accessories are not supplied, depending on the transceiver version.

■ Accessory attachments

◇ Flexible antenna

Connect the supplied flexible antenna to the antenna connector.

/// CAUTION:

- **NEVER** carry the transceiver by holding antenna.
- **DO NOT** connect any antenna other than those listed on page 31.
- Transmitting without an antenna will damage the transceiver.

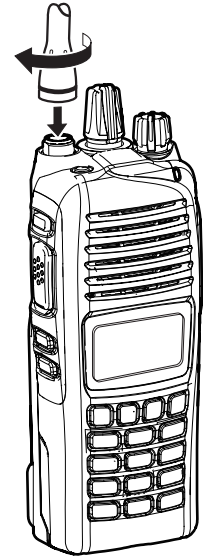

◇ Battery pack

To attach the battery pack:

Slide the battery pack in the direction of the arrow (1) until the battery release button makes a 'click' sound.

/// **NOTE:** Push on the bottom of the pack to make sure the release button is firmly locked.

To remove the battery pack:

Push the battery release button in the direction of the arrow (2), as shown below. The battery pack is then removed.

/// **NEVER** remove or attach the battery pack when the transceiver is wet or soiled. This may result water or dust getting into the transceiver/battery pack and may result in the transceiver being damaged.

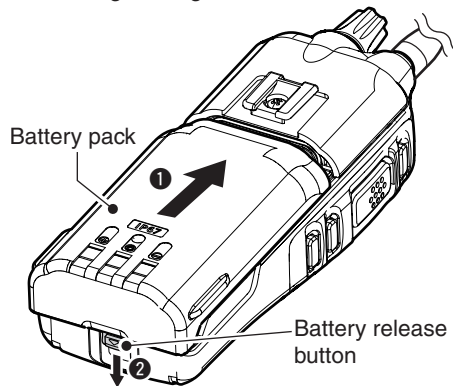

/// **NOTE:** Keep the battery pack terminals clean. It's a good idea to occasionally clean them.

◇ Belt clip

To attach the belt clip:

- ① Remove the battery pack if it is attached.
- ② Slide the belt clip in the direction of the arrow until the belt clip locks and makes a 'click' sound.

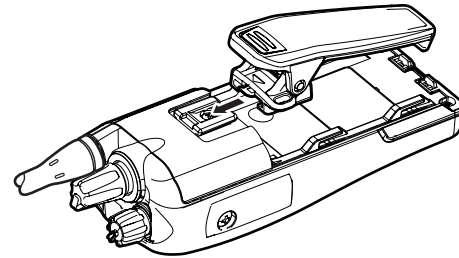

To detach the belt clip:

- ① Remove the battery pack if it is attached.
- ② Pinch the clip (1), and slide the belt clip in the direction of the arrow (2).

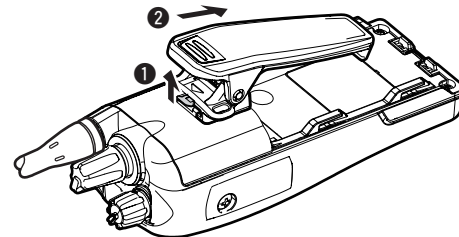

1 ACCESSORIES

◇ Connector cover

To attach the connector cover:

- 1 Place the connector cover over the multi-connector.
- 2 Tighten the screw.

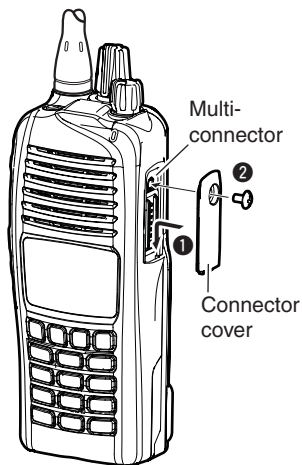

To detach the connector cover:

- 1 Remove the screw using a Phillips screwdriver.
- 2 Detach the connector cover to connect optional equipment.

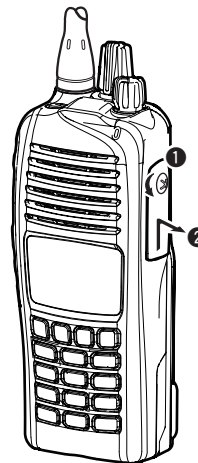

CAUTION:

Attach the connector cover when optional equipment is not used. Otherwise the terminals of the multi-connector may short out, and this could damage the transceiver.

■ Front panel

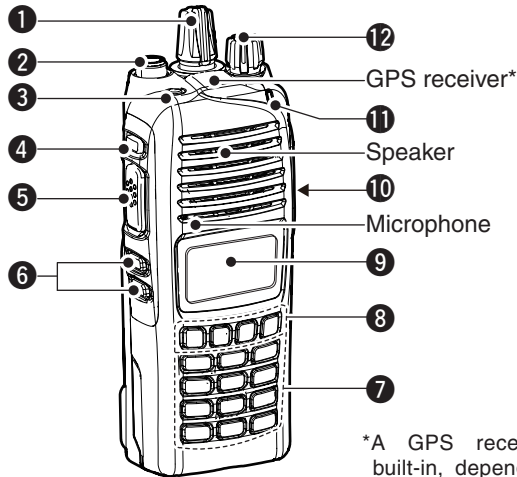

*A GPS receiver is built-in, depending on the transceiver version.

1 ROTARY SELECTOR

Rotate to select the memory channels or the operating zone, depending on the presetting.

2 ANTENNA CONNECTOR

Connect the supplied antenna. (p. 1)

3 DEALER-PROGRAMMABLE KEY [EMR]

Desired functions can be preset by your dealer. (p. 6)

4 DEALER-PROGRAMMABLE KEY [Side1]

Desired functions can be preset by your dealer. (p. 6)

5 PTT SWITCH [PTT]

Hold down to transmit, release to receive.

6 DEALER-PROGRAMMABLE KEYS [Side2]/[Side3]

Desired functions can be preset by your dealer. (p. 6)

7 10-KEYPAD (Depending on the version)

The keypad allows you to enter digits to:

- Select memory channels
- Select tone channels
- Select DTMF codes (during transmit)
- Set TX codes
- Start up with the password

8 DEALER-PROGRAMMABLE KEYS [P0] to [P3]

Desired functions can be preset by your dealer. (p. 6)

9 FUNCTION DISPLAY (p. 5)

Displays a variety of information such as an operating channel number/name, Set mode contents, DTMF code, selected functions and so on.

2 PANEL DESCRIPTION

⑩ MULTI-CONNECTOR

Connects to optional equipment.

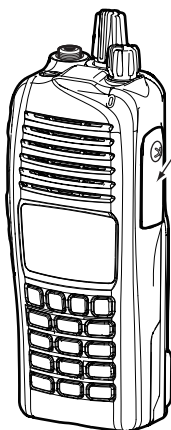

Connector cover

NOTE: Attach the connector cover when optional equipment is not used. See page 3 for details.

⑪ BUSY/TRANSMIT INDICATOR

- ➔ Lights green while receiving a signal, or when the squelch is open.
- ➔ Lights red while transmitting.

⑫ VOLUME CONTROL [VOL]

Rotate to turn the transceiver power ON or OFF, and adjust the audio level.

■ Function display

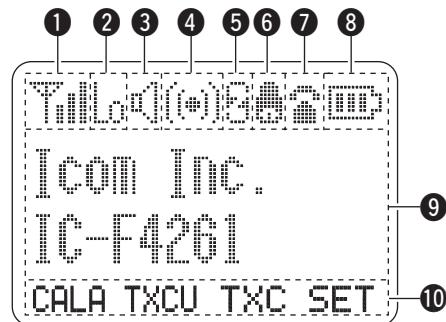

① SIGNAL STRENGTH ICON

Indicates relative signal strength level.

② LOW POWER ICON

Appears when low output power is selected.

- When the battery power decreases to a specified level, low power is automatically selected.

③ AUDIBLE ICON

- ➔ Appears when the channel is in the 'audible' (unmute) mode.
- ➔ Appears when a matched signal is received.

④ COMPANDER ICON

Appears when the compander function is activated.

⑤ SCRAMBLER ICON

Appears when the voice scrambler function is activated.

6 BELL ICON

Appears or blinks when a matched signal is received, depending on the presetting.

7 CALL CODE MEMORY ICON

Appears when the call code memory is selected.

8 BATTERY ICON

Appears or blinks when the battery power decreases to a specified level.

Indication				
Battery level	Full	Mid	Charging required	Exhausted Battery

blinks when the battery is over charged.

blinks when the battery is exhausted.

9 ALPHANUMERIC DISPLAY

- Displays the operating channel number, channel name, Set mode contents, DTMF code, and so on.
- The display mode can be set to one line or two lines. Ask your dealer for details.
 - In this instruction manual, the LCD illustration is described using the two-line display mode.

10 KEY ICONS

Indicates the programmed function of the front panel keys ([P0], [P1], [P2] and [P3]).

■ Programmable function keys

The following functions can be assigned to the [EMR], [Side1], [Side2], [Side3], [P0], [P1], [P2] and [P3] programmable function keys.

Consult your Icom dealer or system operator for details concerning your transceivers programming.

CH UP AND DOWN KEYS “UP” “DOWN”

- Push to select an operating channel. When [Rotary selector] selects “operating channel,” this key is disabled.
- Push to select a transmit code channel after pushing [TX Code CH Select].
- Push to select a DTMF channel after pushing [DTMF Autodial].
- Push to select a scan group after holding down [Scan].
- Push to select the desired application type, individual/talk-group ID, TX status message and SDM (Short Data Message) after pushing [Digital Button].

2 PANEL DESCRIPTION

ZONE KEY “ZONE”

Push this key, then push [CH Up] or [CH Down] to select the desired zone. When [Rotary selector] selects the “operating zone,” this key operation is disabled.

 **What is a “zone”?**— Selected channels are assigned to a zone according to how they are to be used in a group. For example, ‘Staff A’ and ‘Staff B’ are assigned to a “Business” zone, and ‘John’ and ‘Cindy’ are assigned to a “Private” zone.

ZONE UP AND DOWN KEYS “ZNUF” “ZNDN”

Push to select an operating zone. When [Rotary selector] selects an “operating zone,” these keys are disabled.

SCAN KEY “SCAN”

- ➔ Push to start or cancel a scan.
 - When the Power ON Scan function is activated, push to pause the scan. The paused scan resumes after the specified time period has passed.
- ➔ Hold down this key for 1 second to display the scan group, then push [CH Up] or [CH Down] to select the desired group.

SCAN ADD/DEL (TAG) KEY “SCAD”

- ➔ Push to add a channel to, or delete it from the current scan group.
 1. Push to display the scan group, then push [CH Up] or [CH Down] to select the desired group.
 2. Push to add a channel to, or delete it from the selected group.
 3. Hold down for 1 second to exit the scan group selection mode.
- ➔ While a scan is paused on a non-priority channel, push this key to delete the selected channel from the scan group.
 -  Depending on the presetting, the cleared channel may be added to the scan group again after the scan is cancelled. (Nuisance Delete function)

PRIORITY CHANNEL KEYS “PRA” “PRB”

- ➔ Push to select the Priority A or Priority B channel.

PRIORITY CHANNEL (REWRITE) KEYS “PRAR” “PRBR”

- ➔ Push to select the Priority A or Priority B channel.
- ➔ Hold down [Prio A (Rewrite)] or [Prio B (Rewrite)] for 1 second to rewrite the Priority A or Priority B channel as the operating channel.

MEMORY CH 1/2/3/4 KEYS “CH1” “CH2” “CH3” “CH4”

Push to directly select memory channels 1 to 4.

MONI KEY “MON”

- Push to mute and release the CTCSS (DTCS) or 2-tone squelch mute. Open any squelch or deactivate any mute while holding down this key. (LMR operation only)
- Independently activates one or two of the following functions on each channel. (PMR operation only)
 - Hold down to unmute the channel (audio is heard; ‘Audible’ mode).
 - Push to mute the channel (sets to ‘Inaudible’ only).
 - Push after the communication is finished to send a ‘reset code’. (5-tone/BISS operation only)

 **NOTE:** The unmute mode (‘Audible’ mode) may automatically return to the mute mode (‘Inaudible’ mode) after a specified period.

LIGHT KEY “LIGT”

Push to temporarily turn ON the transceiver’s backlight, only when the backlight function is turned OFF in the User set mode.

LOCK KEY “LOCK”

- Hold down for 1 second to electronically lock all programmable keys to prevent accidental frequency changes and unnecessary function access, except the following: [PTT], [Call] (incl. Call A and Call B), [Moni(Audi)], [Light], [Emergency], [Surveillance], [Lone Worker] and [OPT 1/2/3].
- Hold down for 1 second again to turn the lock function OFF.

LONE WORKER KEY “LONE”

Push to turn the Lone Worker function ON or OFF.

- If the Lone Worker function is activated, the Emergency function is automatically turned ON after the specified time period has passed with no operation performed.

HIGH/LOW KEY “H/L”

Push to select the transmit output power temporarily or permanently, depending on the presetting.

- Ask your dealer for the output power level for each selection.

TONE/RAN CH SELECT KEY “T SEL”

- While in the analog mode, push to enter the continuous tone channel selection mode. Then select the desired tone frequency/code setting using [CH Up] or [CH Down]. After the selection, push this key again to set the tone/code.
- While in the digital mode, push to enter the RAN channel selection mode. Then select the desired RAN setting using [CH Up] or [CH Down]. After the selection, push this key again to set the RAN.
- While in the mixed (digital and analog) mode, push to enter the continuous tone channel selection mode. Then select the desired tone frequency/code setting using [CH Up] or [CH Down]. After the selection, push this key to set the tone/code. After that, the RAN channel selection screen appears. Select the desired RAN setting using [CH Up] or [CH Down]. After the selection, push this key again to set the RAN.

2 PANEL DESCRIPTION

C.TONE CH ENT KEY “TSEL”

Push to enter the continuous tone channel selection mode. Then select the desired tone frequency/code setting using [CH Up] or [CH Down]. The selected channel remains set as a continuous tone channel until another channel is designated as such.

TALK AROUND KEY “TA”

Push to turn the talk around function ON or OFF.

- The talk around function equalizes the transmit frequency to the receive frequency for transceiver-to-transceiver communication.

WIDE/NARROW KEY “W/N”

Push to toggle the IF bandwidth between wide and narrow.

DTMF AUTODIAL KEY “DTMA”

Push to enter the DTMF channel selection mode. Then select the desired DTMF channel using [CH Up] or [CH Down]. After selecting the DTMF channel, push again to transmit the selected DTMF code.

RE-DIAL KEY “DTMR”

Push to transmit the last-transmitted DTMF code.

CALL KEYS “CALL” “CALA” “CALB”

Push to transmit a 2/5-tone or BIIS ID code.

- A Call transmission may be necessary before you call another station, depending on your signaling system.
- [Call A] and/or [Call B] may be selectable when your system employs selective ‘Individual/Group’ calls. Ask your dealer which call is assigned to each key.

EMERGENCY KEY “EMR”

Hold down to transmit an emergency call.

- The emergency call transmits and beep sounds. The display does not change.
- The transceiver can transmit the emergency call silently, or with the display changing, depending on the presetting. Ask your dealer for details.
- If you want to cancel the emergency call, hold down the key again before transmitting it.
- The emergency call is transmitted only one time, or repeatedly until receiving a control code, depending on the presetting.

SURVEILLANCE KEY “SURV”

Push to turn the surveillance function ON or OFF.

When this function is turned ON, a beep is not heard and the LCD backlight does not light when a signal is received or a key is pushed.

TX CODE ENTER KEYS “TXCE”

Push to directly enter the ID code edit mode, for both 5-tone and MSK. Then set the desired digit using [CH Up] or [CH Down]. (p. 15)

TX CODE CHANNEL SELECT KEY “TXC”

Push to enter the TX code channel selection mode. Then set the desired channel using [CH Up] or [CH Down]. (pp. 14, 15)

TX CODE CHANNEL UP/DOWN KEYS “TXCU” “TXCD”

Push to select a TX code channel directly.

ID-MEMORY SELECT KEY “IDMS”

- Recalls detected ID codes.
 - Push this key, then select the ID code using [CH Up] or [CH Down].
 - Up to five ID’s can be memorized.
- Hold down for 1 second to erase the selected ID’s.

SCRAMBLER/ENCRYPTION KEY “SCR”

- While in the analog mode operation, push to toggle the voice scrambler function ON or OFF.
- While in the digital mode operation, push to toggle the encryption transmission function ON or OFF.

COMPANDER KEY “COMP”

Push to toggle the compander function ON or OFF. The compander function reduces noise components from the transmitting audio to provide clear communication.

USER SET MODE KEY “SET”

- Hold down for 1 second to enter the User set mode.
 - While in the User set mode, push this key to select an item, and change the value or condition using [CH Up] or [CH Down].
- Hold down this key for 1 second again to exit the User set mode.

OPT OUT KEYS “OP1” “OP2” “OP3”

Push to control the output signal level from the optional unit connector.





OPT MOMENTARY KEYS “O1M” “O2M” “O3M”

Push to control the output signal level from the optional unit connector.

■ Turning power ON

 Prior to using the transceiver for the first time, the battery pack must be fully charged for optimum life and operation. (p. 21)

- ① Rotate [VOL] to turn ON the power.
- ② If the transceiver is programmed for a start up password, input the digit codes as directed by your dealer.
 - The 10-keypad can be used for password input, depending on the transceiver version.
 - The keys in the table below can be used for password input.
 - The transceiver detects numbers in the same block as identical. Therefore “01234” and “56789” are the same.

KEY					(Side1)
NUMBER	0	1	2	3	4
	5	6	7	8	9

- ③ If the “PASSWORD” indication does not clear after inputting 6 digits, the input code number may be incorrect. Turn OFF the power and start over.

◇ Battery type selection

When turning ON the transceiver, the battery type must be selected according to the attached battery type.

- ① Turn OFF the power.
 - ② While holding down [EMR] and [PTT], turn ON the power with rotating [VOL] to toggle the attaching battery type.
 - After the display appears, release [EMR] and [PTT].
 - “DRY BATT” is displayed for about 3 seconds, then the low power icon “Lo” appears when the battery case is selected. The transmit output power is automatically set to low1.
 - “LI-ION” is displayed for about 3 seconds when the Lithium-ion battery pack is selected.
- This operation may not be available, depending on the presetting. Ask your dealer for details.

■ Channel selection

Several types of channel selections are available. Methods may differ, depending on the presetting.

NON-ZONE TYPE:

To select the desired operating channel:

- Push [CH Up] or [CH Down].
- Rotate [ROTARY SELECTOR]*.
 - Up to 16 preprogrammed channels can be selected.
- Push one of [MR-CH 1] to [MR-CH 4].

ZONE TYPE:

To select the desired zone:

- Push [Zone], then push [CH Up] or [CH Down].
- Push [Zone Up] or [Zone Down].
- Rotate [ROTARY SELECTOR]*.
 - Up to 16 preprogrammed zones can be selected.

* Depending on the presetting.

When [Rotary selector] selects "Operating channel," [CH Up]/[CH Down] are disabled.

When [Rotary selector] selects "Operating zone," [Zone Up]/[Zone Down] are disabled.

AUTOMATIC SCAN TYPE:

Channel setting is not necessary for this type. When you turn ON power, the transceiver automatically starts scanning. Scanning stops when a call is received.

◇ Voting operation (for zone selection)

The transceiver automatically starts scanning when a zone, specified for the voting operation, is selected.

The voting scan detects the signal of the repeater and automatically selects the strongest station.

3 BASIC OPERATION

■ Call procedure

When your system employs tone signaling, excluding CTCSS and DTCS, this call procedure may be necessary prior to voice transmission. The tone signaling employed may be a selective calling system which allows you to call only specific station(s) and prevents unwanted stations from contacting you.

- ① Select the desired TX code channel or 2/5-tone code according to your System operator's instructions.
 - This may not be necessary, depending on the presetting.
 - Refer to pages 14 or 15 for selection.
- ② Push [Call], assigned to one of the dealer programmable keys.
- ③ After transmitting, the remainder of your communication can be carried out in the normal way.

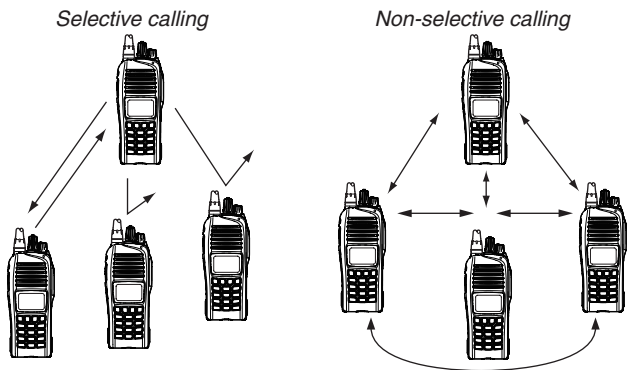

■ Receiving and transmitting

CAUTION: Transmitting without an antenna will damage the transceiver.

Receiving:

- ① Rotate [VOL] to turn ON the power.
- ② Push [CH Up] or [CH Down], or rotate [ROTARY SELECTOR], depending on the presetting, to sequentially select the conventional system channel.
- ③ When receiving a call, adjust the audio output level to a comfortable listening level.

NOTE: When a matched RX code signal is received, audio from the microphone may be automatically transmitted for a specified time period.*

* Depending on the presetting. Ask your dealer for details.

Transmitting:

Wait for the channel to become clear to avoid interference.

- ① While holding down [PTT], speak into the microphone at a normal voice level.
 - When a tone signaling system is used, the call procedure described on the previous page may be necessary.
- ② Release [PTT] to receive.

IMPORTANT: To maximize the audio quality of your signal:

1. Pause briefly after pushing [PTT].
2. Hold the microphone 5 to 10 cm (2 to 4 inches) from your mouth, then speak at a normal voice level.

◇ Transmitting notes

• Transmit inhibit function

The transceiver has several inhibit functions which restrict transmission under the following conditions:

- The channel is muted ('Inaudible' mode; "㊦" (Audible icon) does not appear.)
- The channel is busy.
- Unmatched or matched CTCSS is received, depending on the presetting.
- The selected channel is a 'receive only' channel.

• Time-out timer

After continuous transmission for a preset time period, the time-out timer causes the transceiver to stop transmitting.

• Penalty timer

Once transmission is cut OFF, it is further inhibited for a period determined by the Penalty timer.

◇ TX code channel selection

If the transceiver has [TX Code CH Select] assigned to it, the display can be toggled between the operating channel number or name, and the TX code channel number or name. When the TX code channel number, or name is displayed, pushing [CH Up] or [CH Down] selects the TX code channel.

USING [TX CODE CH SELECT] KEY:

- ① Push [TX Code CH Select]— a TX code channel number or name appears.
- ② Push [CH Up] or [CH Down] to select the desired TX code channel.
- ③ After selecting, push [TX Code CH Select] to set the code.
 - Return to the standby mode.
- ④ Push [Call] to transmit the selected TX code.

USING [TX CODE CH UP]/[TX CODE CH DOWN] KEY:

If the transceiver has a [TX Code CH Up] or [TX Code CH Down] key assigned, the preset TX code channel can be directly selected when pushed.

☞ Continued on the next page

3 BASIC OPERATION

◇ TX code number edit (PMR operation only)

If the transceiver has [TX Code CH Select] or [TX Code Enter] assigned, the TX code contents can be edited within the allowable digits.

USING [TX CODE CH SELECT] KEY:

- ① Push [TX Code CH Select] to enter the TX code channel selection mode.
 - Select the desired operating channel before entering the TX code channel selection mode, if necessary.
- ② Push [TX Code CH Select] for 1 second to enter the TX code edit mode.
 - The digit to be edited blinks.
- ③ Push [TX Code CH Select] to select the desired digit to be edited.
- ④ Push [CH Up] or [CH Down] to select the desired digit.
- ⑤ Push [TX Code CH Select] to set it. The digit to the right will automatically blink.
- ⑥ Repeat ④ and ⑤ to edit all allowable digits.
- ⑦ After editing, push [TX Code CH Select] to set the code.
 - Return to the standby mode.
- ⑧ Push [Call] to transmit.

USING [TX CODE ENTER] KEY:

- ① After pushing [TX Code CH Select], push [CH Up] or [CH Down], or push [TX Code CH Up] or [TX Code CH Down] to select the desired TX code channel.
- ② Push [TX Code Enter] to enter the TX code edit mode.
 - The digit to be edited blinks.
- ③ Push [TX Code Enter] to select the desired digit to be edited.
- ④ Push [CH Up] or [CH Down] to select the desired digit.
- ⑤ Push [TX Code Enter] to set. The digit to the right will automatically blink.
- ⑥ Repeat ④ and ⑤ to edit all allowable digits.
- ⑦ After editing, push [TX Code Enter] to set.
 - Return to the standby mode.
- ⑧ Push [Call] to transmit.

◇ DTMF transmission

If the transceiver has [DTMF Autodial] assigned, the automatic DTMF transmission function can be used. Up to 8 DTMF channels are selectable.

- ① Push [DTMF Autodial]— a DTMF channel appears.
- ② Push [CH Up] or [CH Down] to select the desired DTMF channel.
- ③ Push [DTMF Autodial] to transmit the DTMF code on the selected DTMF channel.

■ User set mode

The User set mode allows you to set seldom-changed settings and “customize” the transceiver operation to suit your preferences and operating style.

Entering the User set mode:

- ① Hold down [SET] for 1 second to enter the User set mode.
- ② Push [SET] several times to select the appropriate item. Then push [CH Up] or [CH Down] to set the desired level or option.
 - In the User set mode, the selectable items are preset by your dealer. The presetable items are **Backlight, LCD contrast, Beep, Beep Level, Ringer Level, SQL Level, AF Min Level, Mic Gain, VOX Gain***, **VOX Delay***, **Battery Voltage, Signal Moni, Lone Worker** and **System Info**.
 - * Appears only when the external VOX unit is connected.
- ③ Hold down [SET] for 1 second again to exit the User set mode.

■ Scrambler function

The voice scrambler function provides private communication between stations. All transceiver versions have a built-in frequency inversion type scrambler.

- ➡ Push [Scrambler] to toggle the scrambler function ON or OFF.
 - “” (Scrambler icon) appears when the function is ON.

■ Stun function

When the specified ID, set as a stun ID or kill ID, is received, the stun function is activated.

When a stun ID is received, the transceiver becomes unusable. Entering the password (p. 11) or receiving a revive ID, is necessary to operate the transceiver again.

When a kill ID is received, the transceiver switches to the cloning required condition. Cloning the transceiver is necessary to operate the transceiver again.

3 BASIC OPERATION

■ Emergency transmission

When [Emergency] is pushed for the specified time period, an emergency signal is transmitted once, or repeatedly, on the specified emergency channel, depending on the presetting.

A repeat emergency signal is automatically transmitted until the transceiver receives an acknowledgement signal, or you turn OFF the transceiver power.

When no emergency channel is specified, the signal is transmitted on the previously selected channel.

If you want to cancel the emergency call, hold down [Emergency] again before transmitting it.

If your transceiver is preset for Silent operation, you can transmit an Emergency call without the beep sounding and the LED indicator lighting.

 **IMPORTANT:** It is recommended to set a separate emergency channel to provide reliable emergency calls.

◇ NOTES

Depending on the presetting, the following functions may be automatically activated. Ask your dealer for details.

• Auto TX function

After the emergency call transmission, audio from the microphone is automatically transmitted for a specified time period.

• Auto RX function

After the emergency call transmission, the transceiver stands by in the audible mode for the specified time period.

■ Man Down Emergency Call

This function is available, depending on the transceiver version. When the transceiver has been left in a horizontal position for the specified time period*, the transceiver enters the emergency mode, and then the countdown starts.

After the specified time period* has passed, an emergency call is automatically transmitted once, or repeatedly.

If the transceiver is placed in a vertical position before the first transmission, the transceiver exits the emergency mode and the emergency call is cancelled.

 **IMPORTANT:** It is recommended to set a separate emergency channel to provide reliable emergency calls.

■ Automatic Key Lock function

When [Lock] is assigned to any key, and the Automatic Key Lock timer is preprogrammed*, the key lock function can be automatically turned ON after the specified time period has passed with no key operation.

While the lock function is ON, hold down [Lock] for 1 second to turn the function OFF.

*When "0" is programmed, this function is disabled.

■ Priority A channel selection

When one of the following operations is performed, the transceiver automatically selects the Priority A channel.

- Turning the power ON
The Priority A channel is selected each time the transceiver power is turned ON.
- Status call
The Priority A channel is selected when transmitting a status call. (BIIS operation only)
- Clear down
The Priority A channel is selected after the clear down signal is transmitted.

■ Caution

Misuse of Lithium-ion batteries may result in the following hazards: smoke, fire, or the battery may rupture. Misuse can also cause damage to the battery or degradation of battery performance.

- ⚠ **DANGER!** Use and charge only specified Icom battery packs with Icom radios or Icom charger. Only Icom battery packs are tested and approved for use and charge with Icom radios or Icom charger. Using third-party or counterfeit battery packs or charger may cause smoke, fire, or cause the battery to burst.

◇ Battery caution

- ⚠ **DANGER! DO NOT** hammer or otherwise impact the battery. Do not use the battery if it has been severely impacted or dropped, or if the battery has been subjected to heavy pressure. Battery damage may not be visible on the outside of the case. Even if the surface of the battery does not show cracks or any other damage, the cells inside the battery may rupture or catch fire.
- ⚠ **DANGER! NEVER** use or leave battery packs in areas with temperatures above +60°C (+140°F). High temperature buildup in the battery, such as could occur near fires or stoves, inside a sun heated car, or in direct sunlight may cause the battery to rupture or catch fire. Excessive temperatures may also degrade battery performance or shorten battery life.
- ⚠ **DANGER! DO NOT** expose the battery to rain, snow, seawater, or any other liquids. Never charge or use a wet battery. If the battery gets wet, be sure to wipe it dry before using. The battery is not waterproof.
- ⚠ **DANGER! NEVER** incinerate used battery packs since internal battery gas may cause them to rupture, or may cause an explosion.
- ⚠ **DANGER! NEVER** solder the battery terminals or NEVER modify the battery pack. This may cause heat generation, and the battery may rupture, emit smoke or catch fire.
- ⚠ **DANGER!** Use the battery only with the transceiver for which it is specified. Never use a battery with any other equipment, or for any purpose that is not specified in this instruction manual.
- ⚠ **DANGER!** If fluid from inside the battery gets in your eyes, blindness can result. Rinse your eyes with clean water, without rubbing them, and see a doctor immediately.

- **⚠ WARNING!** Immediately stop using the battery if it emits an abnormal odor, heats up, or is discolored or deformed. If any of these conditions occur, contact your Icom dealer or distributor.
- **⚠ WARNING!** Immediately wash, using clean water, any part of the body that comes into contact with fluid from inside the battery.
- **⚠ WARNING! NEVER** put the battery in a microwave oven, high-pressure container, or in an induction heating cooker. This could cause a fire, overheating, or cause the battery to rupture.
- **CAUTION:** Always use the battery within the specified temperature range, -20°C to $+60^{\circ}\text{C}$ (-4°F to $+140^{\circ}\text{F}$). Using the battery out of its specified temperature range will reduce the battery's performance and battery life.
- **CAUTION:** Shorter battery life could occur if the battery is left fully charged, completely discharged, or in an excessive temperature environment (above $+50^{\circ}\text{C}$; $+122^{\circ}\text{F}$) for an extended period of time. If the battery must be left unused for a long time, it must be detached from the radio after discharging. You may use the battery until the remaining capacity is about half, then keep it safely in a cool dry place with the temperature range as below:
 - -20°C to $+50^{\circ}\text{C}$ (-4°F to $+122^{\circ}\text{F}$) (within a month)
 - -20°C to $+35^{\circ}\text{C}$ (-4°F to $+95^{\circ}\text{F}$) (within three months)

◇ Charging caution

- **⚠ DANGER! NEVER** charge the battery pack in areas with extremely high temperatures, such as near fires or stoves, inside a sun heated car, or in direct sunlight. In such environments, the safety/protection circuit in the battery will activate, causing the battery to stop charging.
- **⚠ WARNING! NEVER** charge or leave the battery in the battery charger beyond the specified time for charging. If the battery is not completely charged by the specified time, stop charging and remove the battery from the battery charger. Continuing to charge the battery beyond the specified time limit may cause a fire, overheating, or the battery may rupture.
- **⚠ WARNING! NEVER** insert the transceiver (battery attached to the transceiver) into the charger if it is wet or soiled. This could corrode the battery charger terminals or damage the charger. The charger is not waterproof.
- **CAUTION: NEVER** charge the battery outside of the specified temperature range: BC-160 and BC-171 (0°C to $+45^{\circ}\text{C}$; $+32^{\circ}\text{F}$ to $+113^{\circ}\text{F}$), BC-119 and BC-121 ($+10^{\circ}\text{C}$ to $+40^{\circ}\text{C}$; $+50^{\circ}\text{F}$ to $+104^{\circ}\text{F}$). Icom recommends charging the battery at $+20^{\circ}\text{C}$ ($+68^{\circ}\text{F}$). The battery may heat up or rupture if charged out of the specified temperature range. Additionally, battery performance or battery life may be reduced.

4 BATTERY CHARGING

■ Optional battery chargers

◇ Rapid charging with the BC-160

The optional BC-160 provides rapid charging of the Li-ion battery pack.

Charging time: Approximately 3 hours with the BP-232WP

The following items are additionally required:

- An AC adapter (may be supplied with BC-160, depending on version) or the OPC-515L/CP-23L DC power cable.

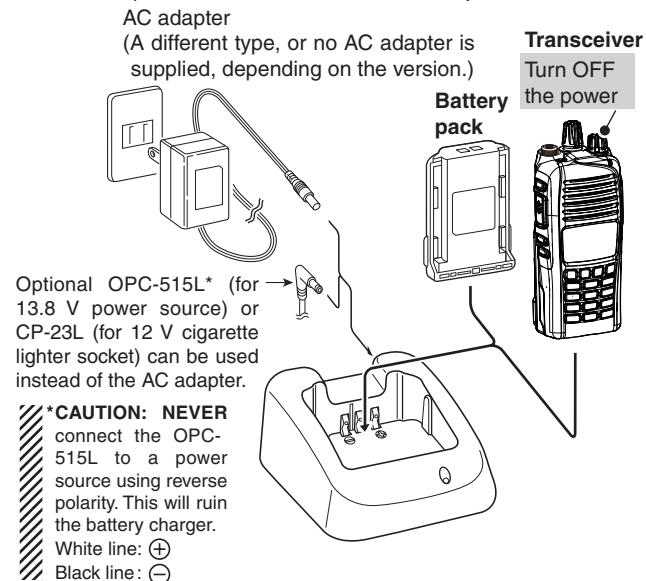

◇ Regular charging with the BC-171

The optional BC-171 provides regular charging of the Li-ion battery pack.

Charging time: Approximately 10 hours with the BP-232WP

The following items are additionally required:

- An AC adapter (may be supplied with BC-171, depending on version) or the OPC-515L/CP-23L DC power cable.

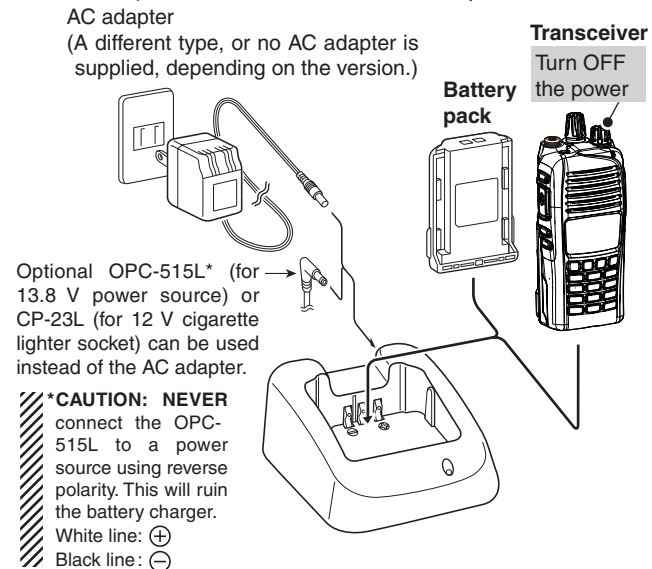

◇ **AD-106 installation**

The AD-106 CHARGER ADAPTER must be installed into the BC-119N or BC-121N before battery charging.

- ① Connect the AD-106 CHARGER ADAPTER and the BC-119N/BC-121N.
- ② Install the AD-106 into the holder space of the BC-119N/BC-121N with the supplied screws.

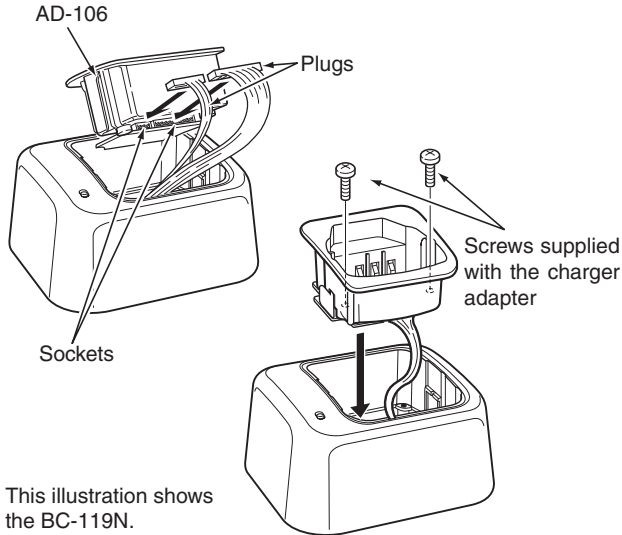

◇ **Rapid charging with the BC-119N+AD-106**

The optional BC-119N provides rapidly charges the Li-ion battery pack.

Charging time: Approximately 3 hours with the BP-232WP

The following items are additionally required.

- AD-106 CHARGER ADAPTER (purchase separately)
- An AC adapter (may be supplied with BC-119N, depending on version) or the OPC-515L/CP-23L DC power cable.

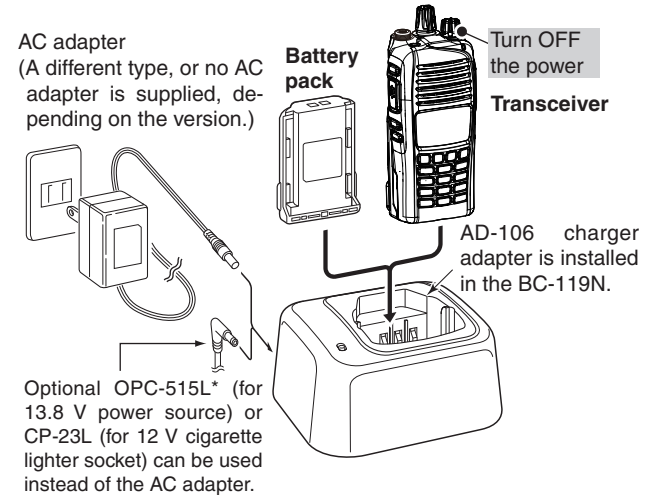

/// ***CAUTION: NEVER** connect the OPC-515L to a power source using reverse polarity. This will ruin the battery charger.
 /// White line: ⊕ Black line: ⊖

4 BATTERY CHARGING

◇ Rapid charging with the BC-121N+AD-106

The optional BC-121N allows up to 6 battery packs to be simultaneously charged.

Charging time: Approximately 3 hours with the BP-232WP

The following items are additionally required.
(purchase separately)

- Six AD-106 CHARGER ADAPTERS
- An AC adapter or the OPC-656 DC power cable

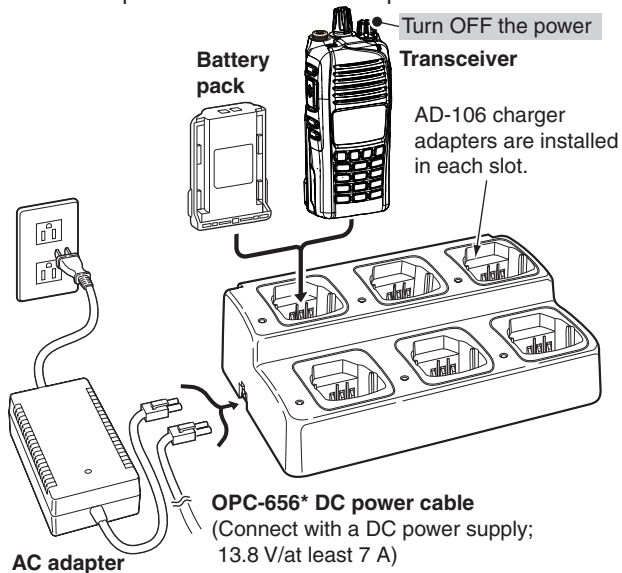

*Polarity of the OPC-656
Red line : ⊕ Black line : ⊖

IMPORTANT: Battery charging caution
Ensure the guide tabs on the battery pack are correctly aligned with the guide rails inside the charger adapter. This illustration is for the BC-160.

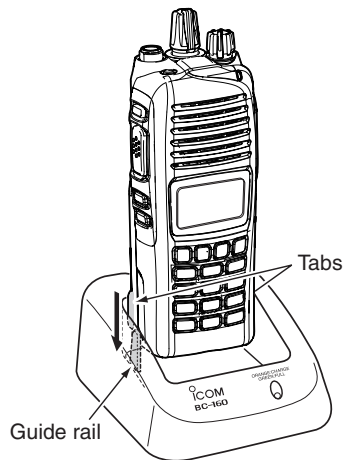

CAUTION:
When using the OPC-656 DC power cable
NEVER reverse the polarity when connecting the OPC-656 to a power source. This will ruin the battery charger.
OPC-656 : Red line: ⊕, Black line: ⊖

■ BP-240 optional battery case

When using the BP-240 battery case, install six AAA (LR03) size alkaline batteries, as illustrated to the right.

- ① Unhook the battery cover release hook (①), and open the cover in the direction of the arrow (②). (Fig.1)
- ② Install six AAA (LR03) size alkaline batteries. (Fig.2)
 - Install only alkaline batteries.
 - Be sure to observe the correct polarity.
- ③ Replace the cover in the direction of the arrow (③), then close (④). Push the battery cover release hook until it makes a 'click' sound (⑤). (Fig.3)

CAUTION:

- When installing the batteries, make sure they are all the same brand, type and capacity. Also, do not mix new and old batteries together.
- Keep battery terminals clean. It's a good idea to occasionally clean them.
- Never incinerate used battery cells since internal battery gas may cause them to rupture.
- Never expose a detached battery case to water. If the battery case gets wet, be sure to wipe it dry before using it.

NOTE: When the optional battery case is attached, the battery type must be set to "DRY BATT" when turning ON the transceiver. (p. 11)

Fig.1

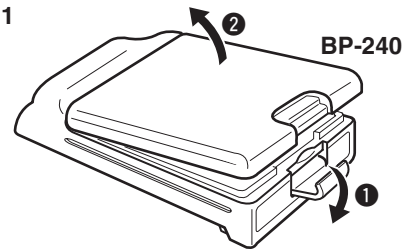

Fig.2

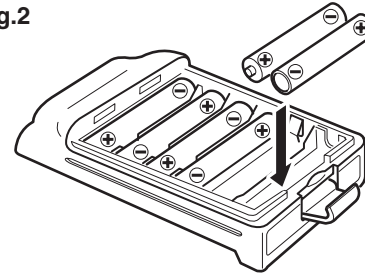
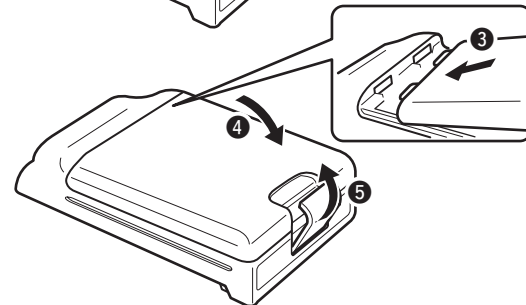

Fig.3



5 BATTERY CASE

■ BP-261 optional battery case

◇ Alkaline batteries installation

Install six AA (LR6) size alkaline batteries as described below.

- ① Unhook the battery cover release hook (1), and open the cover in the direction of the arrow (2). (Fig.1)
- ② Install six AA (LR6) size alkaline batteries. (Fig.2)
 - Install only alkaline batteries.
 - Be sure to observe the correct polarity.
- ③ Replace the cover in the direction of the arrow (3), then close (4). Push the battery cover release hook until it makes a 'click' sound (5). (Fig.3)

CAUTION:

- When installing the batteries, make sure they are all the same brand, type and capacity. Also, do not mix new and old batteries together.
- Keep battery terminals clean. It's a good idea to occasionally clean them.
- Never incinerate used battery cells since internal battery gas may cause them to rupture.
- Never expose a detached battery case to water. If the battery case gets wet, be sure to wipe it dry before using it.

NOTE: When the optional battery case is attached, the battery type must be set to "DRY BATT" when turning ON the transceiver. (p. 11)

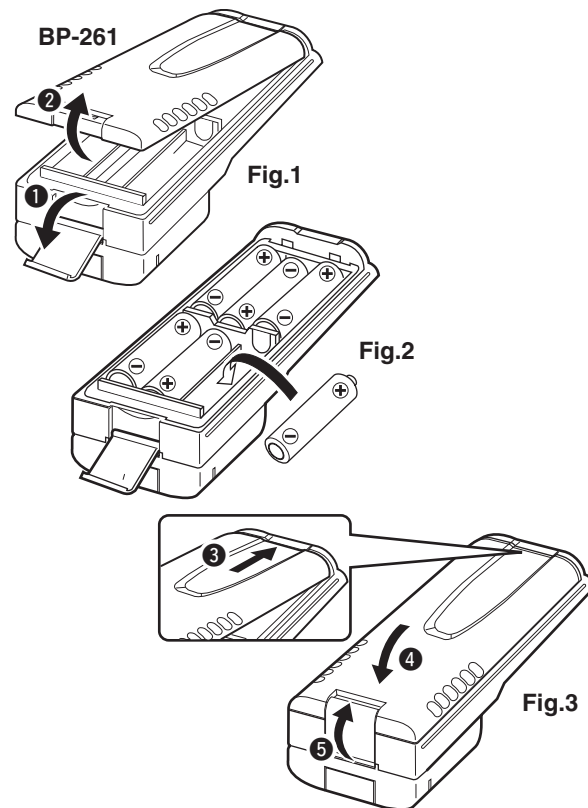

◇ Battery case attachment

Slide the battery pack in the direction of the arrow until the battery release button makes a 'click' sound.

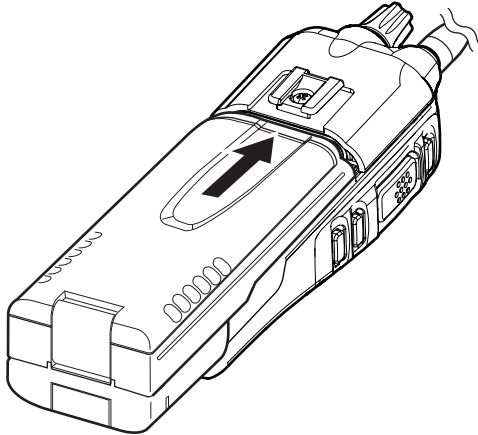

To release the battery case:

Slide the battery case's battery release button in the direction of the arrow (1), and then push the release button in the direction of the arrow (2). The battery pack is then released.

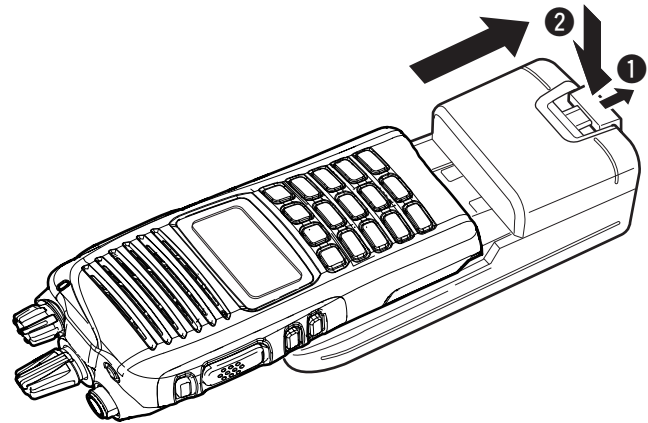

NEVER release or attach the battery case when the transceiver is wet or soiled. This may result in water or dust getting into the transceiver or battery case and may result in the transceiver being damaged.

6

SWIVEL BELT CLIP

■ MB-93 contents

	Qty.
① Belt clip	1
② Base clip	1

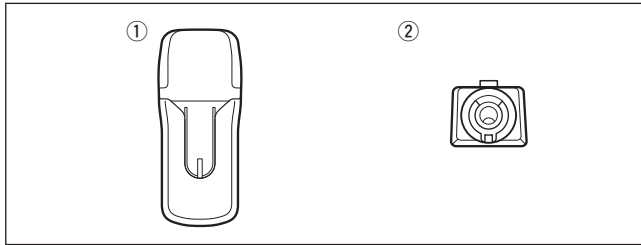

■ To attach

- ① Remove the battery pack if it is attached. (p. 2)
- ② Slide the base clip in the direction of the arrow until it locks and makes a 'click' sound.

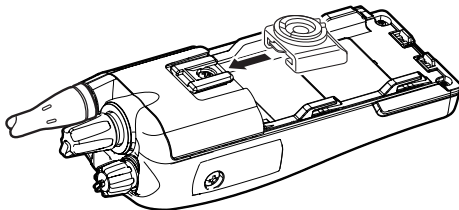

- ③ Attach the battery pack. (p. 2)

- ④ Clip the belt clip to a place on your belt. Insert the transceiver into the belt clip until the base clip is fully inserted into the groove.

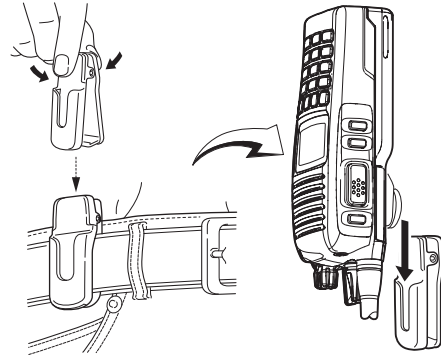

- ⑤ Once the transceiver is locked in place, it swivels, as illustrated below.

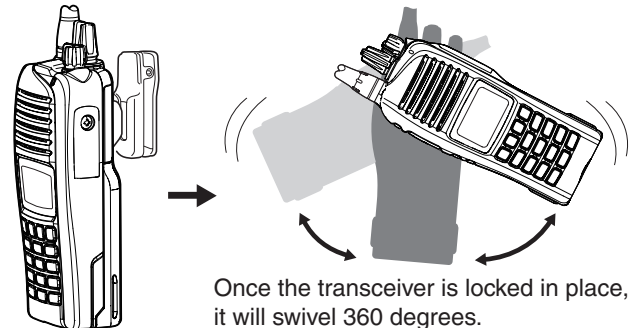

■ To detach

- ① Turn the transceiver upside down in the direction of the arrow and pull it out of the belt clip.

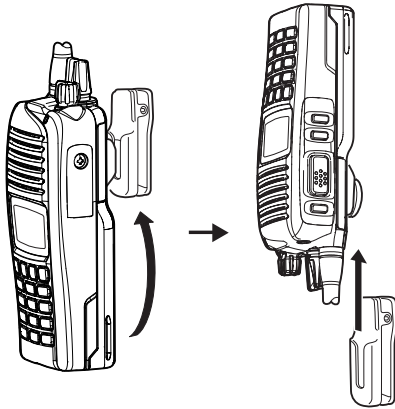

- ② Remove the battery pack if it is attached. (p. 2)
- ③ Pinch the clip (1), and slide the base clip in the direction of the arrow (2).

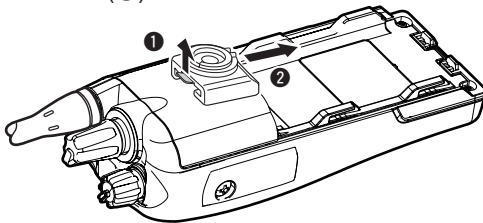

CAUTION:
HOLD THE TRANSCEIVER TIGHTLY WHEN HANGING OR DETACHING THE TRANSCEIVER FROM THE BELT CLIP.
Otherwise the transceiver may not properly attach to the holder or swivel, if the transceiver has been accidentally dropped and the base clip is scratched or damaged.

■ Optional HM-184

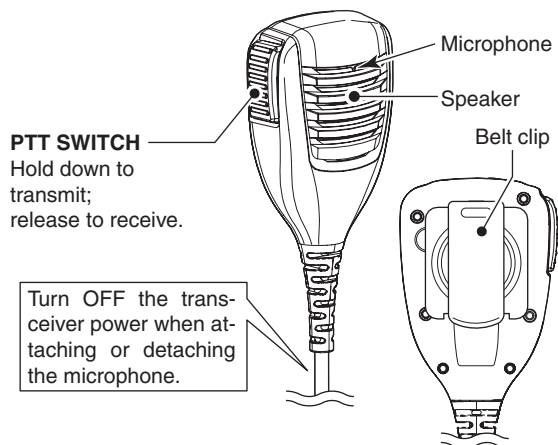

NEVER immerse the connector in water. If the connector becomes wet, be sure to dry it **BEFORE** attaching it to the transceiver.

NOTE: The microphone element is located at the top of the speaker microphone, as shown in the diagram above. To maximize the readability of your transmitted signal (voice), hold the microphone Approximately 5 to 10 cm (2 to 4 inches) from your mouth, and speak at a normal voice level.

■ To attach

Attach the connector of the speaker microphone into the multi connector on the transceiver and tighten the screw.

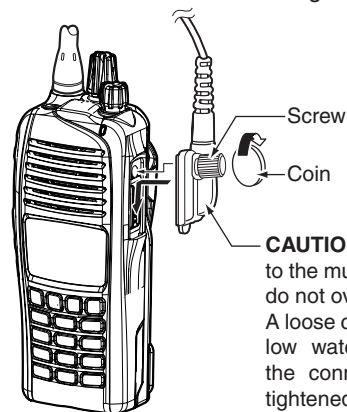

CAUTION: Firmly attach to the multi connector, but do not overtighten.

A loose connection will allow water intrusion into the connector; an overtightened connection will damage the connector pins in the transceiver.

IMPORTANT: KEEP the connector cover attached to the transceiver when the speaker microphone is not in use. (p. 3)

Water will not get into the transceiver, even if the cover is not attached. However, the terminals (pins) will become rusty, or the transceiver will function abnormally if the connector becomes wet.

◇ BATTERY PACKS

• **BP-232WP** LI-ION BATTERY PACK

Voltage: 7.4 V, Capacity: 2250 mAh (min.) 2300 mAh (typ.)

• Battery life

GPS unit	VHF		UHF	
	Digital mode	Analog mode	Digital mode	Analog mode
Built in type	11 hrs.	11.5 hrs.	10.5 hrs.	11 hrs.
non GPS type	13 hrs.	13.5 hrs.	12 hrs.	12.5 hrs.

When the power save function is turned ON, and the operating periods are calculated under the following conditions;

TX : RX : standby = 5 : 5 : 90

• **BP-240** BATTERY CASE

Battery case for AAA (LR03) × 6 alkaline

• **BP-261** BATTERY CASE

Battery case for AA (LR6) × 6 alkaline

◇ DC CABLES

• **CP-23L** CIGARETTE LIGHTER CABLE

Allows charging of the battery pack through a 12 V cigarette lighter socket. For use with the BC-119N/BC-160/BC-171

• **OPC-515L/OPC-656** DC POWER CABLES

Allows charging of the battery pack using a 13.8 V power source instead of the AC adapter.

OPC-515L : For BC-119N

OPC-656 : For BC-121N

◇ CHARGERS

• **BC-119N** DESKTOP CHARGER + **AD-106** CHARGER ADAPTER + **BC-145S** AC ADAPTER

For rapid charging of battery packs. An AC adapter may be supplied with the charger, depending on the version.

Charging time: Approximately 3 hours.

• **BC-121N** MULTI-CHARGER + **AD-106** CHARGER ADAPTER (6 pcs.) + **BC-157S** AC ADAPTER

For rapid charging of up to 6 battery packs simultaneously. Six AD-106s are required. An AC adapter should be purchased separately.

Charging time: Approximately 3 hours.

• **BC-160** DESKTOP CHARGER + **BC-145S** AC ADAPTER

For rapid charging of battery packs. An AC adapter may be supplied with the charger, depending on the version.

Charging time: Approximately 3 hours.

• **BC-171** DESKTOP CHARGER + **BC-147S** AC ADAPTER

For regular charging of battery packs. An AC adapter may be supplied with the charger, depending on the version.

Charging time: Approximately 10 hours.

◇ BELT CLIPS

• **MB-93** SWIVEL BELT CLIP

• **MB-94R** BELT CLIP

Exclusive alligator-type belt clip.

• **MB-96N/96F** LEATHER BELT HANGER

8 OPTIONS

◇ ANTENNAS

- **FA-SC56VS/FA-SC57VS/FA-SC73US** STUBBY ANTENNAS

Shorter VHF or UHF antennas.

FA-SC56VS: Frequency range 150–162 MHz

FA-SC57VS: Frequency range 160–174 MHz

FA-SC73US: Frequency range 450–490 MHz

- **FA-SC25V/FA-SC55V/FA-SC03U/**

FA-SC25U/FA-SC57U/FA-SC72U FLEXIBLE ANTENNAS

VHF or UHF antennas.

FA-SC25V: Frequency range 136–150 MHz

FA-SC55V: Frequency range 150–174 MHz

FA-SC03U: Frequency range 380–430 MHz

FA-SC25U: Frequency range 400–430 MHz

FA-SC57U: Frequency range 430–470 MHz

FA-SC72U: Frequency range 470–520 MHz

- **FA-SC61VC/FA-SC61UC** CUT ANTENNAS

FA-SC61VC: 136–174 MHz

FA-SC61UC: 380–520 MHz

- **FA-SC62V/FA-SC63V** HIGH GAIN ANTENNAS

FA-SC62V: 150–160 MHz

FA-SC63V: 155–165 MHz

◇ OTHER OPTIONS

- **AD-118** ACC ADAPTER

Allows you to connect an accessory which uses a HIROSE plug. See the instruction sheet of the AD-118 for details of the recommended accessories.

 **CAUTION:** The AD-118 does not have any waterproof protection. When it is connected, NEVER expose the adaptor and the transceiver to rain, snow or any liquids.

- **HM-184** SPEAKER MICROPHONE

Rugged type speaker microphone.

- **MB-130** VEHICLE CHARGER BRACKET

Mounts the BC-160 DESKTOP CHARGER on to variety of place in vehicle.

Approved Icom optional equipment is designed for optimal performance when used with an Icom transceiver. Icom is not responsible for the destruction or damage to an Icom transceiver in the event the Icom transceiver is used with equipment that is not manufactured or approved by Icom.

Some options may not be available in some countries. Please ask your dealer for details.



WARNING

Your Icom radio generates RF electromagnetic energy during transmit mode. This radio is designed for and classified as “Occupational Use Only;” meaning it must be used only during the course of employment by individuals aware of the hazards, and the ways to minimize such hazards. This radio is NOT intended for use by the “General Population” in an uncontrolled environment. This radio has been tested and complies with the FCC RF exposure limits for “Occupational Use Only.” In addition, your Icom radio complies with the following Standards and Guidelines with regard to RF energy and electromagnetic energy levels and evaluation of such levels for exposure to humans:

- FCC OET Bulletin 65 Edition 97-01 Supplement C, Evaluating Compliance with FCC Guidelines for Human Exposure to Radio Frequency Electromagnetic Fields.
- American National Standards Institute (C95.1-1992), IEEE Standard for Safety Levels with Respect to Human Exposure to Radio Frequency Electromagnetic Fields, 3 kHz to 300 GHz.
- American National Standards Institute (C95.3-1992), IEEE Recommended Practice for the Measurement of Potentially Hazardous Electromagnetic Fields— RF and Microwave.
- The following accessories are authorized for use with this product. Use of accessories other than those specified may result in RF exposure levels exceeding the FCC requirements for wireless RF exposure; Belt Clip (MB-93, MB-94, MB-96N and MB-96F), Rechargeable Li-ion Battery Pack (BP-232WP), Alkalies Battery Case (BP-240 and BP-261) and Speaker microphone (HM-184).



CAUTION

To ensure that your exposure to RF electromagnetic energy is within the FCC allowable limits for occupational use, always adhere to the following guidelines:

- **DO NOT** operate the radio without a proper antenna attached, as this may damage the radio and may also cause you to exceed FCC RF exposure limits. A proper antenna is the antenna supplied with this radio by the manufacturer or antenna specifically authorized by the manufacturer for use with this radio.
- **DO NOT** transmit for more than 50% of total radio use time (“50% duty cycle”). Transmitting more than 50% of the time can cause FCC RF exposure compliance requirements to be exceeded. The radio is transmitting when the TX indicator lights red. You can cause the radio to transmit by pressing the “VOX/PTT” switch.
- **ALWAYS keep** the antenna at least 2.5 cm (1 inch) away from the body when transmitting and only use the Icom belt-clips listed on page 30 when attaching the radio to your belt, etc., to ensure FCC RF exposure compliance requirements are not exceeded. To provide the recipients of your transmission the best sound quality, hold the antenna at least 5 cm (2 inches) from your mouth, and slightly off to one side.

The information listed above provides the user with the information needed to make him or her aware of RF exposure, and what to do to assure that this radio operates with the FCC RF exposure limits of this radio.

Electromagnetic Interference/Compatibility

During transmissions, your Icom radio generates RF energy that can possibly cause interference with other devices or systems. To avoid such interference, turn OFF the radio in areas where signs are posted to do so. **DO NOT** operate the transmitter in areas that are sensitive to electromagnetic radiation such as hospitals, aircraft, and blasting sites.

Occupational/Controlled Use

The radio transmitter is used in situations in which persons are exposed as a consequence of their employment provided those persons are fully aware of the potential for exposure and can exercise control over their exposure.

9 SAFETY TRAINING INFORMATION



Votre radio Icom produit une énergie électromagnétique de radiofréquences (RF), en mode de transmission. Cette radio est conçue pour un «usage professionnel seulement» et classée comme tel, ce qui signifie qu'elle

AVERTISSEMENT doit être utilisée uniquement dans le cadre d'un travail par des personnes conscientes des dangers et des mesures visant à minimiser ces dangers. Elle N'EST PAS conçue pour une «utilisation grand public», dans un environnement non contrôlé.

Cet appareil a été évalué et jugé conforme, aux limites d'exposition aux RF de la FCC, pour une «utilisation grand public». En outre, votre radio Icom satisfait les normes et directives qui suivent en matière de niveaux d'énergie et d'énergie électromagnétique de RF et d'évaluation de tels niveaux en ce qui concerne l'exposition humaine:

- Supplément C, édition 97-01, du Bulletin OET n° 65 de la FCC, «Evaluating Compliance with FCC Guidelines for Human Exposure to Radio Frequency Electromagnetic Fields».
- Norme de l'American National Standards Institute (ANSI): IEEE C95.1-1992 sur les niveaux de sécurité compatibles avec l'exposition humaine aux champs électromagnétiques de radiofréquences (3 kHz à 300 GHz).
- Norme de l'ANSI: IEEE C95.3-1992 sur la méthode d'évaluation recommandée du champ magnétique potentiellement dangereux des radiofréquences et des micro-ondes.
- Les accessoires illustrés à la p. 30–31 sont approuvés pour une utilisation avec ce produit. L'utilisation d'accessoires autres que ceux précisés peut entraîner des niveaux d'exposition aux RF supérieures aux limites établies par la FCC en matière d'exposition aux RF sans fil.



MISE EN GARDE

Afin de vous assurer que votre exposition à une énergie électromagnétique de RF se situe dans les limites permises par la FCC pour une utilisation grand public, veuillez en tout temps respecter les directives suivantes:

- **NE PAS** faire fonctionner la radio sans qu'une antenne appropriée y soit fixée, car ceci risque d'endommager la radio et causer une exposition supérieure aux limites établies par la FCC. L'antenne appropriée est celle qui est fournie avec cette radio par le fabricant ou une antenne spécialement autorisée par le fabricant pour être utilisée avec cette radio.
- **NE PAS** émettre pendant plus de 50 % du temps total d'utilisation de l'appareil («50 % du facteur d'utilisation»). La notion «50% du facteur d'utilisation» s'applique également au mode VOX/PTT. Émettre pendant plus de 50 % du temps total d'utilisation peut causer une exposition aux RF supérieure aux limites établies par la FCC. Lorsque le voyant DEL rouge s'allume, cette radio est en train d'émettre. La radio émettra si vous appuyez sur le bouton du microphone.
- **TOUJOURS tenir** l'antenne éloignée d'au moins 2,5 cm de votre corps au moment d'émettre et utiliser uniquement l'attache pour ceinture Icom illustrée à la p. 30, lorsque vous attachez la radio à votre ceinture, ou à autre chose, de façon à vous assurer de ne pas provoquer une exposition aux RF supérieure aux limites fixées par la FCC. Pour offrir à vos interlocuteurs la meilleure qualité de transmission possible, tenez l'antenne à au moins 5 cm de votre bouche et légèrement de côté.

Les renseignements ci-dessus fournissent à l'utilisateur toute l'information nécessaire sur l'exposition aux RF et sur ce qu'il faut faire pour assurer que cette radio fonctionne en respectant les limites d'exposition aux RF établies par la FCC.

Interférence électromagnétique et compatibilité

En mode de transmission, votre radio Icom produit de l'énergie de RF qui peut provoquer des interférences avec d'autres appareils ou systèmes. Pour éviter de telles interférences, mettez la radio hors tension dans les secteurs où une signalisation l'exige. **NE PAS** faire fonctionner l'émetteur dans des secteurs sensibles au rayonnement électromagnétique tels que les hôpitaux, les aéronefs et les sites de dynamitage.

Usage professionnel/contrôlé

Ce radio émetteur est utilisé dans des cas où des personnes sont exposées en raison de leur travail, pourvu qu'elles soient conscientes du risque d'exposition et qu'elles puissent exercer un contrôle sur cette exposition.

Count on us!

A-7016D-1EX-②a
Printed in Japan
© 2012 Icom Inc.

Printed on recycled paper with soy ink.

Icom Inc.

1-1-32 Kamiminami, Hirano-ku, Osaka 547-0003, Japan